

Design of timber structures

Rules and formulas
according to Eurocode 5

Volume 2



Produced in co-operation with Timber Development UK





Design of timber structures Volumes 1–3 are adapted to Eurocode 5, Eurocode 0 and Eurocode 1.

- Volume 1: Structural aspects of timber construction
- Volume 2: Rules and formulas according to Eurocode 5
- Volume 3: Examples

Preface

This is the first UK edition of *Design of timber structures Volume 2, Rules and formulas according to Eurocode 5* published in 2015. Rules and standards change in pace with the development of society, hence a publication of this type needs to be reviewed regularly. Contrary to earlier English editions, the current version is not adapted to the Swedish national choices in Eurocode 1995. Instead, the original Eurocode 1995 is referred to, in order to simplify adaptation to different national parameters in the country using the book.

The book series *Design of timber structures Volume 1–3* has been produced to make it easier for structural designers to calculate timber structures and it is adapted to Eurocodes. It is being used for higher education at universities and institutes.

The book series *Design of timber structures Volume 1–3* includes *Volume 1, Structural aspects of timber construction* as well as *Volume 3, Examples*. All three books are available in English and Swedish. Since the books are available in both languages and due to the nuanced content, our goal is that they will play a role for many users on different skill levels. Notice that the Swedish decimal holder “,” was kept throughout all the text, instead of the English “.”. All photos are taken in Sweden, unless otherwise indicated.

Tord Isaksson and Sven Thelandersson at the Faculty of Engineering at Lund University have been responsible for compilation and editing of *Volume 2*, in collaboration with the authors of the three books. The authors are Roberto Crocetti, Marie Johansson, Robert Kliger, Helena Lidelöw, Annika Mårtensson, Bert Norlin and Anna Pousette.

More information about wood, glulam and timber construction can be found at www.swedishwood.com.

Stockholm, August 2022

Patrice Godonou
Swedish Wood

Contents

Introduction 5

General concepts 5

- 2.1 Load duration classes 5
- 2.2 Service classes 6
- 2.3 Load combination factors ψ 6

Material properties 7

- 3.1 Design value for strength in the ultimate limit states, ULS 7
- 3.2 Strength modification factor k_{mod} 8
- 3.3 Size effects 9
- 3.4 Material properties for standardized wood products 10
- 3.5 Final modulus of elasticity 20

Bending 21

Axial loading 22

- 5.1 Tension 22
- 5.2 Compression 23

Cross section subjected to shear 25

Cross section subjected to combined stresses 26

- 7.1 Compression stresses at an angle to the grain 26
- 7.2 Combined bending and axial tension 26
- 7.3 Combined bending and axial compression 27

Members with varying cross section or curved shape 28

- 8.1 Tapered beams 28
- 8.2 Double tapered, curved and pitched cambered beams 29
- 8.3 Notched members 31

Serviceability limit states, SLS 32

- 9.1 General 32
- 9.2 Joint slip 33
- 9.3 Deflections 34
- 9.4 Vibrations 35

Connections with metal fasteners 36

- 10.1 General 36
- 10.2 Shear capacity of wood-wood and panel-wood connections 36
- 10.3 Shear capacity of steel-to-wood connections 38
- 10.4 Nailed connections 40
- 10.5 Bolted and dowelled connections 44
- 10.6 Screwed connections 46

Wall diaphragms 49

- 11.1 Simplified analysis method A 49
- 11.2 Simplified analysis method B 50

Bracing 51

- 12.1 Single members in compression 51
- 12.2 Bracing of beam or truss systems 52

Symbols 53

Non-liability and copyright 57

Publications and websites from Swedish Wood 59

Introduction

The purpose with this document is to present formulas, data and design rules related to the European standard EN 1995-1-1 in a convenient and easy to read manner.

This document is primarily intended for education purposes and should not be referred to as an official document in practical structural design. For that purpose the original documents EN 1995-1-1 and other associated EN standards should be used.

General concepts

2.1 Load duration classes

Table 2.1 Load duration classes

Load duration classes	Accumulated duration	Examples of loading
Permanent (P)	> 10 years	Self weight
Long-term (L)	6 months – 10 years	Storage
Medium-term (M)	1 week – 6 months	Imposed floor load Snow load
Short-term (S)	< 1 week	Wind load Snow load
Instantaneous (I)		Wind gusts Accidental load

Source: Table according to EN 1995-1-1:2004, 2.3.1.2.

- 2.1 Load duration classes 5
- 2.2 Service classes 6
- 2.3 Load combination factors ψ 6

2.2 Service classes (EN 1995-1-1, 2.3.1.3)

Service class 1

The average moisture content for most softwood species will not exceed 12 %, which corresponds to an environment with temperature of 20 °C and relative humidity only exceeding 65 % a few weeks per year.

Examples: Building elements in a heated indoor environment, such as internal walls.

Service class 2

The average moisture content for most softwood species will not exceed 20 %, which corresponds to an environment with temperature of 20 °C and relative humidity only exceeding 85 % a few weeks per year.

Examples: Wooden elements which are ventilated and protected against direct precipitation, such as roof trusses, attic and crawl space floors. Structures in ventilated buildings which are not permanently heated or premises with activities or storage not generating moisture, such as summer houses, unheated attics, garages and storages, farm buildings and crawl spaces ventilated by outdoor air.

Service class 3

The average moisture content for most softwood species exceeds 20 %, which gives a higher moisture content than that specified for service class 2.

Examples: Structures not protected from precipitation or in ground contact, and scaffoldings.

2.3 Load combination factors ψ

Table 2.2 Load combination factors

Load	ψ_0	ψ_1	ψ_2
Imposed load in buildings, category ¹⁾			
A: Residential areas	0,7	0,5	0,3
B: Office areas	0,7	0,5	0,3
C: Assembly areas	0,7	0,7	0,6
D: Shopping areas	0,7	0,7	0,6
E: Storage areas	1,0	0,9	0,8
F: Traffic area, vehicle weight ≤ 30 kN	0,7	0,7	0,6
G: Traffic area, 30 kN \leq vehicle weight ≤ 160 kN	0,7	0,5	0,3
H: Roofs	0	0	0
Snow load			
Finland, Iceland, Norway, Sweden	0,7	0,5	0,2
Rest of Europe, $H > 1\ 000$ m above sea level	0,7	0,5	0,2
Rest of Europe, $H \leq 1\ 000$ m above sea level	0,5	0,2	0
Wind load	0,6	0,2	0
Thermal load (non-fire) in buildings	0,6	0,5	0

¹⁾ Category according to EN 1991-1-1.

Source: Table according to EN 1990, table A1.1.

Material properties

3.1 Design value for strength in the ultimate limit states, ULS

$$f_d = \frac{k_{\text{mod}} \cdot f_k}{\gamma_M}$$

where:

- f_d design value for strength parameter.
- f_k characteristic value for strength parameter.
- k_{mod} modification factor taking into account the effect on strength parameters.
- γ_M partial coefficient for material, see table 3.1.

- 3.1 Design value for strength in the ultimate limit states, ULS 7
- 3.2 Strength modification factor k_{mod} 8
- 3.3 Size effects 9
- 3.4 Material properties for standardized wood products 10
 - 3.4.1 Structural timber 10
 - 3.4.2 Glued laminated timber (glulam) 12
 - 3.4.3 Laminated veneer lumber (LVL) 14
 - 3.4.4 Fibreboards 15
 - 3.4.5 Particleboards 17
 - 3.4.6 Oriented strand boards (OSB) 18
 - 3.4.7 Plywood 19
- 3.5 Final modulus of elasticity 20

Table 3.1 Partial coefficient γ_M for materials in ultimate limit state

This is a Nationally Determined Parameter (NDP). In the UK, refer to BS NA EN1995-1-1, the UK national Annex to EN 1995-1-1 (Eurocode 5).

Material	γ_M
Structural timber	1,3
Glued laminated timber	1,25
LVL, plywood, OSB	1,2
Particleboard	1,3
Fibreboard (hard, medium, MDF)	1,3
Wood connections ¹⁾	1,3
Punched metal plate connections ²⁾	1,25

¹⁾ Refers to all types of connections in a wooden construction, unless otherwise stated.

²⁾ Refers to connections with pressed punched metal plate fasteners carried out under controlled conditions.

Source: Table according to EN 1995-1-1:2004, 2.4.1.

3.2 Strength modification factor k_{mod}

In a connection between wood materials with different values of k_{mod} , the strength modification factor can be determined as:

$$k_{\text{mod}} = \sqrt{k_{\text{mod},1} k_{\text{mod},2}}$$

where $k_{\text{mod},i}$ is the strength modification factor of the materials 1 and 2.

Table 3.2 Strength modification factors k_{mod} for service classes and load-duration classes

Material	Associated material standard	Service class	Load duration class				
			P	L	M	S	I
Structural timber	EN 14081-1	1	0,60	0,70	0,80	0,90	1,10
		2	0,60	0,70	0,80	0,90	1,10
		3	0,50	0,55	0,65	0,70	0,90
Glulam	EN 14080	1	0,60	0,70	0,80	0,90	1,10
		2	0,60	0,70	0,80	0,90	1,10
		3	0,50	0,55	0,65	0,70	0,90
Laminated veneer lumber (LVL)	EN 14374 EN 14279	1	0,60	0,70	0,80	0,90	1,10
		2	0,60	0,70	0,80	0,90	1,10
		3	0,50	0,55	0,65	0,70	0,90
Plywood	EN 636						
	Type 1	1	0,60	0,70	0,80	0,90	1,10
	Type 2	2	0,60	0,70	0,80	0,90	1,10
	Type 3	3	0,50	0,55	0,65	0,70	0,90
Oriented strand board (OSB)	EN 300						
	OSB/2	1	0,30	0,45	0,65	0,85	1,10
	OSB/3, OSB/4	1	0,40	0,50	0,70	0,90	1,10
	OSB/3, OSB/4	2	0,30	0,40	0,55	0,70	0,90
Particleboard	EN 312						
	Type P4, P5	1	0,30	0,45	0,65	0,85	1,10
	Type P5	2	0,20	0,30	0,45	0,60	0,80
	Type P6, P7	1	0,40	0,50	0,70	0,90	1,10
	Type P7	2	0,30	0,40	0,55	0,70	0,90
Fibreboard, hard	EN 622-2						
	HB.LA, HB.HLA 1, 2	1	0,30	0,45	0,65	0,85	1,10
	HB.HLA 1, 2	2	0,20	0,30	0,45	0,60	0,80
Fibreboard, medium	EN 622-3						
	MBH.LA 1, 2	1	0,20	0,40	0,60	0,80	1,10
	MBH.HLS 1, 2	1	0,20	0,40	0,60	0,80	1,10
	MBH.HLS 1, 2	2	¹⁾	¹⁾	¹⁾	0,45	0,80
Fibreboard, MDF	EN 622-5						
	MDF.LA, MDF.HLS	1	0,20	0,40	0,60	0,80	1,10
	MDF.HLS	2	¹⁾	¹⁾	¹⁾	0,45	0,80

¹⁾ In service class 2 fibreboards of classes MBH.HLS1, MBH.HLS2 and MDF.HLS are not allowed to be used in load duration classes P, L and M.

Source: Table according to EN 1995-1-1:2004, 3.1.3.

3.3 Size effects

For some materials and failure modes size effects, also called volume effects, may be considered, see EN 1995-1-1, 3.2–3.4.

Structural timber in bending and tension: For depths smaller than 150 mm the characteristic values $f_{m,k}$ and $f_{t,0,k}$ may be increased by the factor k_h where:

$$k_h = \min \left\{ \begin{array}{l} \left(\frac{150}{h} \right)^{0,2} \\ 1,3 \end{array} \right.$$

with:

h section depth in mm.

Glued laminated timber in bending and tension: For rectangular cross sections with depths smaller than 600 mm, values for $f_{m,k}$ and $f_{t,0,k}$ may be increased by a factor k_h where:

$$k_h = \min \left\{ \begin{array}{l} \left(\frac{600}{h} \right)^{0,1} \\ 1,1 \end{array} \right.$$

with:

h section depth in mm.

Laminated veneer lumber (LVL) in bending: For other depths than 300 mm, value for $f_{m,k}$ should be corrected by a factor k_h where:

$$k_h = \min \left\{ \begin{array}{l} \left(\frac{300}{h} \right)^s \\ 1,2 \end{array} \right.$$

with:

h section depth in mm.

s parameter for size effect, see section 3.4.3, page 14.

LVL in tension: The reference length in tension is 3 000 mm. For other lengths the tension strength $f_{t,0,k}$ should be multiplied with the factor k_ℓ where:

$$k_\ell = \min \left\{ \begin{array}{l} \left(\frac{3000}{\ell} \right)^{s/2} \\ 1,1 \end{array} \right.$$

with:

ℓ length in mm.

Values of the parameter s for size effect of LVL given in EN 14374 shall be used, see also section 3.4.3, page 14.



Vasaplan, Umeå.

3.4 Material properties for standardized wood products

3.4.1 Structural timber

Table 3.3 Characteristic strength and stiffness properties in MPa and densities in kg/m³ for structural timber in strength classes C14 – C40

Property	C14	C16	C18	C20	C22
Strength values					
Bending parallel to grain $f_{m,k}$	14	16	18	20	22
Tension parallel to grain $f_{t,0,k}$	7,2	8,5	10	11,5	13
Tension perpendicular to grain $f_{t,90,k}$	0,4	0,4	0,4	0,4	0,4
Compression parallel to grain $f_{c,0,k}$	16	17	18	19	20
Compression perpendicular to grain $f_{c,90,k}$	2,0	2,2	2,2	2,3	2,4
Shear $f_{v,k}$	3,0	3,2	3,4	3,6	3,8
Stiffness value for capacity analysis					
Elastic modulus $E_{0,05}$	4 700	5 400	6 000	6 400	6 700
Stiffness values for deformation calculations, mean values					
Elastic modulus parallel to grain $E_{0,mean}$	7 000	8 000	9 000	9 500	10 000
Elastic modulus perpendicular to grain $E_{90,mean}$	230	270	300	320	330
Shear modulus G_{mean}	440	500	560	590	630
Density					
Density ρ_k ¹⁾	290	310	320	330	340
Density ρ_{mean} ²⁾	350	370	380	400	410
Property					
	C24	C27	C30	C35	C40
Strength values					
Bending parallel to grain $f_{m,k}$	24	27	30	35	40
Tension parallel to grain $f_{t,0,k}$	14,5	16,5	19	22,5	26
Tension perpendicular to grain $f_{t,90,k}$	0,4	0,4	0,4	0,4	0,4
Compression parallel to grain $f_{c,0,k}$	21	22	24	25	27
Compression perpendicular to grain $f_{c,90,k}$	2,5	2,5	2,7	2,7	2,8
Shear $f_{v,k}$	4,0	4,0	4,0	4,0	4,0
Stiffness value for capacity analysis					
Elastic modulus $E_{0,05}$	7 400	7 700	8 000	8 700	9 400
Stiffness values for deformation calculations, mean values					
Elastic modulus parallel to grain $E_{0,mean}$	11 000	11 500	12 000	13 000	14 000
Elastic modulus perpendicular to grain $E_{90,mean}$	370	380	400	430	470
Shear modulus G_{mean}	690	720	750	810	880
Density					
Density ρ_k ¹⁾	350	360	380	390	400
Density ρ_{mean} ¹⁾	420	430	460	470	480

¹⁾ ρ_k corresponds to the 0,05 percentile.

²⁾ ρ_{mean} corresponds to the 0,50 percentile.

Source: Table according to EN 338:2016.

The shear strength for rolling shear in structural timber is approximately equal to twice the tension strength perpendicular to grain according to EN 1995-1-1, 6.1.7, that is 0,8 MPa. See figure 3.1.

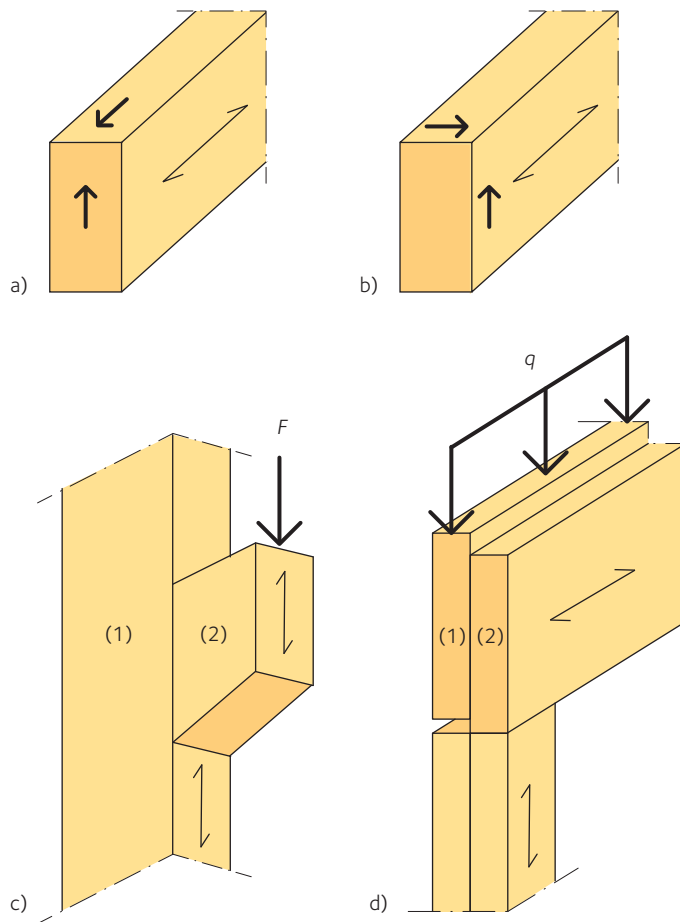

Figure 3.1 a) Member with a shear stress component perpendicular to grain (shear).
 b) Member with both shear stress components perpendicular to grain (rolling shear).
 Two practical examples. c) Glued wooden cleat on column, shear between contact surfaces (1) and (2).
 d) Two beams glued together, rolling shear between contact surfaces (1) and (2).

3.4.2 Glued laminated timber (glulam)

Table 3.4 Characteristic strength and stiffness properties in MPa and densities in kg/m³ for combined (c), homogeneous (h) and resawn (s) glulam ^{1) 2)}

Property	GL22c	GL24c	GL26c	GL28c	GL28cs	GL30c	GL32c
Strength values							
Bending parallel to grain $f_{m,k}$ ³⁾	22	24	26	28	28	30	32
Tension parallel to grain $f_{t,0,k}$	16	17	19	19,5	19,5	19,5	19,5
Tension perpendicular to grain $f_{t,90,k}$	0,5	0,5	0,5	0,5	0,5	0,5	0,5
Compression parallel to grain $f_{c,0,k}$	20	21,5	23,5	24	24	24,5	24,5
Compression perpendicular to grain $f_{c,90,k}$	2,5	2,5	2,5	2,5	2,5	2,5	2,5
Shear $f_{v,k}$ (shear and torsion)	3,5	3,5	3,5	3,5	3,5	3,5	3,5
Rolling shear $f_{r,k}$	1,2	1,2	1,2	1,2	1,2	1,2	1,2
Stiffness values for capacity analysis							
Elastic modulus $E_{0,05}$	8 600	9 100	10 000	10 400	10 400	10 800	11 200
Elastic modulus $E_{90,05}$	250	250	250	250	250	250	250
Shear modulus G_{05}	540	540	540	540	540	540	540
Stiffness values for deformation calculations, mean values							
Elastic modulus $E_{0,mean}$	10 400	11 000	12 000	12 500	12 500	13 000	13 500
Elastic modulus $E_{90,mean}$	300	300	300	300	300	300	300
Shear modulus G_{mean}	650	650	650	650	650	650	650
Density							
Density ρ_k	355	365	385	390	390	390	400
Density ρ_{mean}	390	400	420	420	430	430	440
Property							
Property	GL22h	GL24h	GL26h	GL28h	GL28hs	GL30h	GL32h
Strength values							
Bending parallel to grain $f_{m,k}$ ³⁾	22	24	26	28	28	30	32
Tension parallel to grain $f_{t,0,k}$	17,6	19,2	20,8	22,4	22,4	24	25,6
Tension perpendicular to grain $f_{t,90,k}$	0,5	0,5	0,5	0,5	0,5	0,5	0,5
Compression parallel to grain $f_{c,0,k}$	22	24	26	28	28	30	32
Compression perpendicular to grain $f_{c,90,k}$	2,5	2,5	2,5	2,5	2,5	2,5	2,5
Shear $f_{v,k}$ (shear and torsion)	3,5	3,5	3,5	3,5	3,5	3,5	3,5
Rolling shear $f_{r,k}$	1,2	1,2	1,2	1,2	1,2	1,2	1,2
Stiffness values for capacity analysis							
Elastic modulus $E_{0,05}$	8 800	9 600	10 100	10 500	10 500	11 300	11 800
Elastic modulus $E_{90,05}$	250	250	250	250	250	250	250
Shear modulus G_{05}	540	540	540	540	540	540	540
Stiffness values for deformation calculations, mean values							
Elastic modulus $E_{0,mean}$	10 500	11 500	12 100	12 600	13 100	13 600	14 200
Elastic modulus $E_{90,mean}$	300	300	300	300	300	300	300
Shear modulus G_{mean}	650	650	650	650	650	650	650
Density							
Density ρ_k	370	385	405	425	430	430	440
Density ρ_{mean}	410	420	445	460	480	480	490

¹⁾ Here index g (for glulam) has been omitted in the property designations.

²⁾ The characteristic values for bending and tension are valid for glulam with a depth of 600 mm.
For effect of size see section 3.3, page 9.

³⁾ The bending strength relative to the weak axis is assumed to be equal to the bending strength relative to the strong axis.

Source: Table according to EN 14080:2013.

Table 3.5 Manufacturing assortment for glulam columns and glulam beams produced in Sweden, in current strength classes

Width <i>b</i> (mm)	42	56	66	78	90	115	140	160	165	190	215
Depth <i>h</i> (mm)											
90	GL28hs	GL28hs	GL28hs	GL28hs	GL30h	GL30h	GL30h		GL30h	GL30h	GL30h
115						GL30h	GL30h		GL30h	GL30h	GL30h
135	GL28hs	GL28hs	GL28hs	GL28hs	GL30h	GL30h	GL30h		GL30h	GL30h	GL30h
140							GL30h				
160								GL30h			
165									GL30h		
180	GL28cs	GL28cs	GL28cs	GL28cs	GL30c	GL30c	GL30c	GL30c	GL30c	GL30c	GL30c
225	GL28cs	GL28cs	GL28cs	GL28cs	GL30c	GL30c	GL30c		GL30c	GL30c	GL30c
270	GL28cs	GL28cs	GL28cs	GL28cs	GL30c	GL30c	GL30c		GL30c	GL30c	GL30c
315	GL28cs	GL28cs	GL28cs	GL28cs	GL30c	GL30c	GL30c		GL30c	GL30c	GL30c
360	GL28cs*	GL28cs	GL28cs	GL28cs	GL30c	GL30c	GL30c		GL30c	GL30c	GL30c
405	GL28cs*	GL28cs	GL28cs	GL28cs	GL30c	GL30c	GL30c		GL30c	GL30c	GL30c
450		GL28cs	GL28cs	GL28cs	GL30c	GL30c	GL30c		GL30c	GL30c	GL30c
495		GL28cs*	GL28cs	GL28cs	GL30c	GL30c	GL30c		GL30c	GL30c	GL30c
540		GL28cs*	GL28cs*	GL28cs	GL30c	GL30c	GL30c		GL30c	GL30c	GL30c
585			GL28cs*	GL28cs	GL30c	GL30c	GL30c		GL30c	GL30c	GL30c
630			GL28cs*	GL28cs*	GL30c	GL30c	GL30c		GL30c	GL30c	GL30c
675				GL28cs*	GL30c	GL30c	GL30c		GL30c	GL30c	GL30c
720				GL28cs*	GL30c	GL30c	GL30c		GL30c	GL30c	GL30c
765				GL28cs*	GL30c	GL30c	GL30c		GL30c	GL30c	GL30c
810					GL30c	GL30c	GL30c		GL30c	GL30c	GL30c
855					GL30c	GL30c	GL30c		GL30c	GL30c	GL30c
900					GL30c	GL30c	GL30c		GL30c	GL30c	GL30c
945						GL30c	GL30c		GL30c	GL30c	GL30c
990						GL30c	GL30c		GL30c	GL30c	GL30c
1 035						GL30c	GL30c		GL30c	GL30c	GL30c
1 080						GL30c	GL30c		GL30c	GL30c	GL30c
1 125						GL30c	GL30c		GL30c	GL30c	GL30c
1 170							GL30c		GL30c	GL30c	GL30c
1 215							GL30c		GL30c	GL30c	GL30c
1 260							GL30c		GL30c	GL30c	GL30c
1 305							GL30c		GL30c	GL30c	GL30c
1 350							GL30c		GL30c	GL30c	GL30c
1 395							GL30c		GL30c	GL30c	GL30c
1 440									GL30c	GL30c	GL30c
1 485									GL30c	GL30c	GL30c
1 530									GL30c	GL30c	GL30c
1 575									GL30c	GL30c	GL30c
1 620									GL30c	GL30c	GL30c

Bold = Stock assortment for glulam columns and glulam beams produced in Sweden.

* Resawn glulam in the strength classes GL28cs and GL28hs shall have a depth-/width ratio $h/b \leq 8/1$.

If a resawn glulam beam with a depth-/widthratio $h/b > 8$ satisfies the strength verifications, the depth of the glulam beam may however be increased with maintained width, if desired (yet for practical reasons a maximum depth-/widthratio of $h/b = 10$ is recommended).

Talk to your supplier for UK sizes.

Explanation:

h = homogeneous, c = combined, s = split (resawn).

3.4.3 Laminated veneer lumber (LVL)

Table 3.6 Characteristic strength and stiffness properties in MPa and densities in kg/m³ for LVL ¹⁾

Property	Kerto-S Thickness 21–90 mm	Kerto-Q Thickness 21–24 mm	Kerto-Q Thickness 27–69 mm
Strength values			
Bending edgewise $f_{m,0,edge,k}$	44	28	32
- Size effect parameter s	0,12	0,12	0,12
Bending flatwise, parallel to grain $f_{m,0,flat,k}$ (thickness 21–90 mm)	50	32	36
Bending flatwise, perpendicular to grain $f_{m,90,flat,k}$	-	8,0 ²⁾	8,0
Tension parallel to grain $f_{t,0,k}$	35	19	26
Tension edgewise, perpendicular to grain $f_{t,90,edge,k}$	0,8	6,0	6,0
Tension flatwise, perpendicular to grain $f_{t,90,flat,k}$	-	-	-
Compression parallel to grain $f_{c,0,k}$	35	19	26
Compression edgewise, perpendicular to grain $f_{c,90,edge,k}$	6	9	9
Compression flatwise, perpendicular to grain $f_{c,90,flat,k}$	1,8	2,2	2,2
Shear edgewise $f_{v,0,edge,k}$	4,1	4,5	4,5
Shear flatwise, parallel to grain $f_{v,0,flat,k}$	2,3	1,3	1,3
Shear flatwise, perpendicular to grain $f_{v,90,flat,k}$	-	0,6	0,6
Stiffness values for capacity analysis			
Elastic modulus			
- parallel to grain, along $E_{0,k}$	11 600	8 300	8 800
- parallel to grain, across $E_{90,k}$	-	1 000 ²⁾	1 700
- edgewise, perpendicular to grain $E_{90,edge,k}$	350	2 000	2 000
- flatwise, perpendicular to grain $E_{90,flat,k}$	100	100	100
Shear modulus			
- edgewise $G_{0,edge,k}$	400	400	400
- flatwise, parallel to grain $G_{0,flat,k}$	400	60	100
- flatwise, perpendicular to grain $G_{90,flat,k}$	-	16	16
Stiffness values for deformation calculations, mean values			
Elastic modulus			
- parallel to grain, along $E_{0,mean}$	13 800	10 000	10 500
- parallel to grain, across $E_{90,mean}$	-	1 200 ²⁾	2 000
- edgewise, perpendicular to grain $E_{90,edge,mean}$	430	2 400	2 400
- flatwise, perpendicular to grain $E_{90,flat,mean}$	130	130	130
Shear modulus			
- edgewise $G_{0,edge,mean}$	600	600	600
- flatwise, parallel to grain $G_{0,flat,mean}$	600	60	120
- flatwise, perpendicular to grain $G_{90,flat,mean}$	-	22	22
Density			
Density ρ_k	480	480	480
Density ρ_{mean}	510	510	510

¹⁾ The values in the table are based on a technical approval (VTT Certificate No 184/03, dated 2012) for the dominating European supplier (Metsä Wood) of LVL (Kerto) and are not valid for products from other suppliers. For more information about and peculiarities for Kerto as well as common LVL-dimensions, see VTT Certificate No 184/03 provided by the supplier.

²⁾ For the lay up I–III–I the values 14,0; 2 900 and 3 300 can be used instead of the values 8,0; 1 000 and 1 200.

3.4.4 Fibreboards

Table 3.7 Characteristic strength and stiffness properties in MPa and densities in kg/m³ for fibreboards ^{1) 3)}
Hardboards (humid conditions HB.HLA2) and medium boards (dry conditions MBH.LA2).

Property	Hardboards (EN 622-2) HB.HLA2			Medium boards (EN 622-3) MBH.LA2	
	Nominal thickness t_{nom} (mm)				
	≤ 3,5	> 3,5 – 5,5	> 5,5	≤ 10	> 10
Strength values					
Bending f_m	37	35	32	17	15
Tension f_t	27	26	23	9	8
Compression f_c	28	27	24	9	8
Panel shear f_v	19	18	16	5,5	4,5
Planar shear f_r	3	3	2,5	0,3	0,25
Mean stiffness values ²⁾					
Bending E_m	5 000	4 800	4 600	3 100	2 900
Tension and compression E_t, E_c	5 000	4 800	4 600	3 100	2 900
Panel shear G_v	2 100	2 000	1 900	1 300	1 200
Density					
Density ρ_k	900	850	800	650	600

¹⁾ The values shall be modified by k_{mod} or k_{def} according to *table 3.2, page 8*, and *table 9.1, page 32*.
MBH.LA2 may only be used in service class 1. HB.HLA2 may be used also in service class 2.

²⁾ 5th percentile values are determined as 0,8 times the mean values.

³⁾ The availability of board types and board thicknesses should be checked with the board manufacturers or board suppliers before design is made.

Table 3.8 Characteristic strength and stiffness properties in MPa and densities in kg/m³ for MDF^{1) 3)} MDF.HLS for humid conditions and MDF.LA for dry conditions (EN 622-5).

Property	Type	Nominal thickness t_{nom} (mm)			
		> 1,8 – 12	> 12 – 19	> 19 – 30	> 30
Strength values					
Bending f_m	MDF.HLS	22,0	22,0	21,0	18,0
	MDF.LA	21,0	21,0	21,0	19,0
Tension f_t	MDF.HLS	18,0	16,5	16,0	13,0
	MDF.LA	13,0	12,5	12,0	10,0
Compression f_c	MDF.HLS	18,0	16,5	16,0	13,0
	MDF.LA	13,0	12,5	12,0	10,0
Panel shear f_v	MDF.HLS	8,5	8,5	8,5	7,0
	MDF.LA	6,5	6,5	6,5	5,0
Mean stiffness values²⁾					
Bending E_m	MDF.HLS	3 700	3 200	3 100	2 800
	MDF.LA	3 700	3 000	2 900	2 700
Tension and compression E_t, E_c	MDF.HLS	3 100	2 800	2 700	2 400
	MDF.LA	2 900	2 700	2 000	1 600
Panel shear G_v	MDF.HLS	1 000	1 000	1 000	800
	MDF.LA	800	800	800	600
Density					
Density ρ_k	MDF.HLS	650	600	550	500
	MDF.LA	650	600	550	500

¹⁾ The values shall be modified by k_{mod} or k_{def} according to table 3.2, page 8, and table 9.1, page 32.

MDF.LA may only be used in service class 1. MDF.HLS may be used also in service class 2 in load duration class S and I.

²⁾ 5th percentile values are determined as 0,85 times the mean values.

³⁾ The availability of board types and board thicknesses should be checked with the board manufacturers or board suppliers before design is made.

Source: Tables according to EN 12369-1:2001.

3.4.5 Particleboards

Table 3.9 Characteristic strength and stiffness properties in MPa and densities in kg/m³ for particleboards ^{1) 4)}

Property	Type ²⁾	Nominal thickness t_{nom} (mm)					
		> 6-13	> 13 – 20	> 20 – 25	> 25 – 32	> 32 – 40	> 40
Bending f_m	P4	14,2	12,5	10,8	9,2	7,5	5,8
	P5	15,0	13,3	11,7	10,0	8,3	7,5
	P6	16,5	15,0	13,3	12,5	11,7	10,0
	P7	18,3	16,7	15,4	14,2	13,3	12,5
Tension f_t	P4	8,9	7,9	6,9	6,1	5,0	4,4
	P5	9,4	8,5	7,4	6,6	5,6	5,6
	P6	10,5	9,5	8,5	8,3	7,8	7,5
	P7	11,5	10,6	9,8	9,4	9,0	8,0
Compression f_c	P4	12,0	11,1	9,6	9,0	7,6	6,1
	P5	12,7	11,8	10,3	9,8	8,5	7,8
	P6	14,1	13,3	12,8	12,2	11,9	10,4
	P7	15,5	14,7	13,7	13,5	13,2	13,0
Panel shear f_v	P4	6,6	6,1	5,5	4,8	4,4	4,2
	P5	7,0	6,5	5,9	5,2	4,8	4,4
	P6	7,8	7,3	6,8	6,5	6,0	5,5
	P7	8,6	8,1	7,9	7,4	7,2	7,0
Planar shear f_r	P4	1,8	1,6	1,4	1,2	1,1	1,0
	P5	1,9	1,7	1,5	1,3	1,2	1,0
	P6	1,9	1,7	1,7	1,7	1,7	1,7
	P7	2,4	2,2	2,0	1,9	1,9	1,8
Mean stiffness values ³⁾							
Bending E_m	P4	3 200	2 900	2 700	2 400	2 100	1 800
	P5	3 500	3 300	3 000	2 600	2 400	2 100
	P6	4 400	4 100	3 500	3 300	3 100	2 800
	P7	4 600	4 200	4 000	3 900	3 500	3 200
Tension E_t Compression E_c	P4	1 800	1 700	1 600	1 400	1 200	1 100
	P5	2 000	1 900	1 800	1 500	1 400	1 300
	P6	2 500	2 400	2 100	1 900	1 800	1 700
	P7	2 600	2 500	2 400	2 300	2 100	2 000
Panel shear G_v	P4	860	830	770	680	600	550
	P5	960	930	860	750	690	660
	P6	1 200	1 150	1 050	950	900	880
	P7	1 250	1 200	1 150	1 100	1 050	1 000
Density							
Density ρ_k	P4	650	600	550	550	500	500
	P5	650	600	550	550	500	500
	P6	650	600	550	550	500	500
	P7	650	600	550	550	500	500

¹⁾ The values shall be modified by k_{mod} or k_{def} according to table 3.2, page 8, and table 9.1, page 32.

MDF may only be used in service classes according to table 3.1, EN 1995-1-1.

Particle boards type 5 and 7 may be used also in service class 2.

²⁾ Particle boards are classified in types P4 – P7 according to EN 312, parts 4 – 7 respectively.³⁾ 5th percentile values are determined as 0,8 times the mean values.⁴⁾ The availability of board types and board thicknesses should be checked with the board manufacturers or board suppliers before design is made.

Source: Table according to EN 12369-1:2001.

3.4.6 Oriented strand boards (OSB)

Table 3.10 Characteristic strength and stiffness properties in MPa and densities in kg/m³ for OSB^{1) 6)}

Nominal thickness t_{nom} (mm)	OSB/2, OSB/3 ⁴⁾			OSB/4 ⁴⁾		
	> 6 – 10	> 10 – 18	> 18 – 25	> 6 – 10	> 10 – 18	> 18 – 25
Strength values						
Bending f_m parallel to the strands // ²⁾	18,0	16,4	14,8	24,5	23,0	21,0
Bending f_m perpendicular to the strands \perp ³⁾	9,0	8,2	7,4	13,0	12,2	11,4
Tension f_t parallel to the strands // ²⁾	9,9	9,4	9,0	11,9	11,4	10,9
Tension f_t perpendicular to the strands \perp ³⁾	7,2	7,0	6,8	8,5	8,2	8,0
Compression f_c parallel to the strands // ²⁾	15,9	15,4	14,8	18,1	17,6	17,0
Compression f_c perpendicular to the strands \perp ³⁾	12,9	12,7	12,4	14,3	14,0	13,7
Panel shear f_v	6,8	6,8	6,8	6,9	6,9	6,9
Planar shear f_r	1,0	1,0	1,0	1,1	1,1	1,1
Mean stiffness values⁵⁾						
Bending E_m parallel to the strands // ²⁾	4 930	4 930	4 930	6 780	6 780	6 780
Bending E_m perpendicular to the strands \perp ³⁾	1 980	1 980	1 980	2 680	2 680	2 680
Tension E_t parallel to the strands // ²⁾	3 800	3 800	3 800	4 300	4 300	4 300
Tension E_t perpendicular to the strands \perp ³⁾	3 000	3 000	3 000	3 200	3 200	3 200
Compression E_c parallel to the strands // ²⁾	3 800	3 800	3 800	4 300	4 300	4 300
Compression E_c perpendicular to the strands \perp ³⁾	3 000	3 000	3 000	3 200	3 200	3 200
Panel shear G_v	1 080	1 080	1 080	1 090	1 090	1 090
Planar shear G_r	50	50	50	60	60	60
Density						
Density ρ_k	550	550	550	550	550	550

1) The values shall be modified by k_{mod} or k_{def} according to table 3.2, page 8, and table 9.1, page 32. OSB/2 may only be used in service class 1. OSB/3 and OSB/4 may be used also in service class 2.

2) Parallel to the strands in the outer layer.

3) Perpendicular to the strands in the outer layer.

4) Oriented strand boards are classified in types OSB/2-OSB/4, according to EN 300.

5) 5th percentile values are determined as 0,85 times the mean values.

6) The availability of board types and board thicknesses should be checked with the board manufacturers or board suppliers before design is made.

Source: Table according to EN 12369-1:2001.

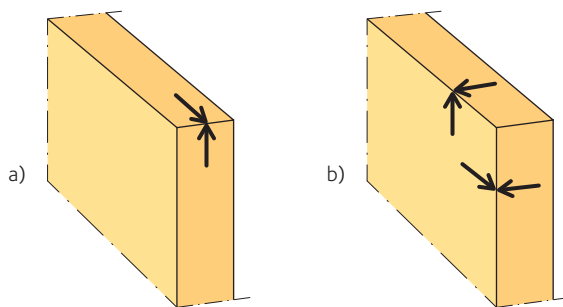

Figure 3.2 Definition of a) panel shear and b) planar shear.

3.4.7 Plywood

Table 3.11 Characteristic strength values of plywood, to be used in structural design¹⁾

Strength class ²⁾	Characteristic strength values (MPa)		
	Surface grain direction ²⁾		
	0 and 90	0	90
	Bending f_m	Tension f_t Compression f_c	
F3	3	1,2	1,5
F5	5	2	2,5
F10	10	4	5
F15	15	6	7,5
F20	20	8	10
F25	25	10	12,5
F30	30	12	15
F40	40	16	20
F50	50	20	25
F60	60	24	30
F70	70	28	35
F80	80	32	40

¹⁾ The values shall be modified by k_{mod} according to table 3.2, page 8.

²⁾ Classes is to be identified for both parallel to grain (0) and perpendicular to grain (90) direction.

The F classes for strength are defined in EN 636.

Table 3.12 Classification for modulus of elasticity of plywood in bending, tension and compression¹⁾

Class for stiffness ²⁾	Mean modulus (MPa) ³⁾		
	Surface grain direction ²⁾		
	0 and 90	0	90
	Bending E_m	Tension E_t Compression E_c	
E5	500	250	400
E10	1 000	500	800
E15	1 500	750	1 200
E20	2 000	1 000	1 600
E25	2 500	1 250	2 000
E30	3 000	1 500	2 400
E40	4 000	2 000	3 200
E50	5 000	2 500	4 000
E60	6 000	3 000	4 800
E70	7 000	3 500	5 600
E80	8 000	4 000	6 400
E90	9 000	4 500	7 200
E100	10 000	5 000	8 000
E120	12 000	6 000	9 600
E140	14 000	7 000	11 200

¹⁾ The values shall be modified by k_{def} according to table 9.1, page 32.

²⁾ Classes is to be identified for both parallel to grain (0) and perpendicular to grain (90) direction.

The E classes for stiffness are defined in EN 636.

³⁾ 5th percentile values shall be determined as described below.

Note The classes for strength (F) and stiffness (E) shall be identified in both directions, 0 and 90, based on bending properties, see EN 636. Values for tension and compression in directions 0 and 90 should be determined based on the classes valid for the same directions.

The 5th percentile for stiffness is taken as X times the mean values given in table 3.12, where:

- X = 0,67 for panels containing wood species with a mean density < 640 kg/m³.
- X = 0,84 for panels containing wood species with a mean density ≥ 640 kg/m³.

When the 5th percentile $\rho_{w,05}$ of the density is known the mean value can be derived from:

$$\rho_{w,mean} = \frac{\rho_{w,05}}{0,823}$$

Table 3.13 Mean shear stiffness and characteristic shear strength for plywood^{1) 2)}

$\rho_{w,mean}$ (kg/m ³)	G_v	f_v	G_r	f_r
	(MPa)			
350	220	1,8	7,3	0,4
400	270	2,7	11	0,5
450	310	3,5	16	0,6
500	360	4,3	22	0,7
550	400	5,0	32	0,8
600	440	5,7	44	0,9
650	480	6,3	60	1,0
700	520	6,9	82	1,1
750	550	7,5	110	1,2

¹⁾ The values shall be modified by k_{mod} or k_{def} according to table 3.2, page 8, and table 9.1, page 32.

²⁾ The availability of board types and board thicknesses should be checked with the board manufacturers or board suppliers before design is made.

Source: Tables according to EN 12369-2:2011.

3.5 Final modulus of elasticity

In structural analysis of section forces in the ultimate limit state, where stiffness of the structural elements is of importance the final modulus of elasticity $E_{\text{mean,fin}}$ should be determined by:

$$E_{\text{mean,fin}} = \frac{E_{\text{mean}}}{1 + \psi_2 k_{\text{def}}}$$

with:

E_{mean} mean value of modulus of elasticity.

ψ_2 the quasi-permanent load combination factor for the action causing the largest stress in relation to the strength.

k_{def} factor that accounts for moisture effects on deformation.

An analogous expression should be applied for the shear modulus G_{mean} and the slip modulus K_{ser} for dowel-type joints.

Also see *Chapter 9, page 32*, in this volume (*Volume 2*).

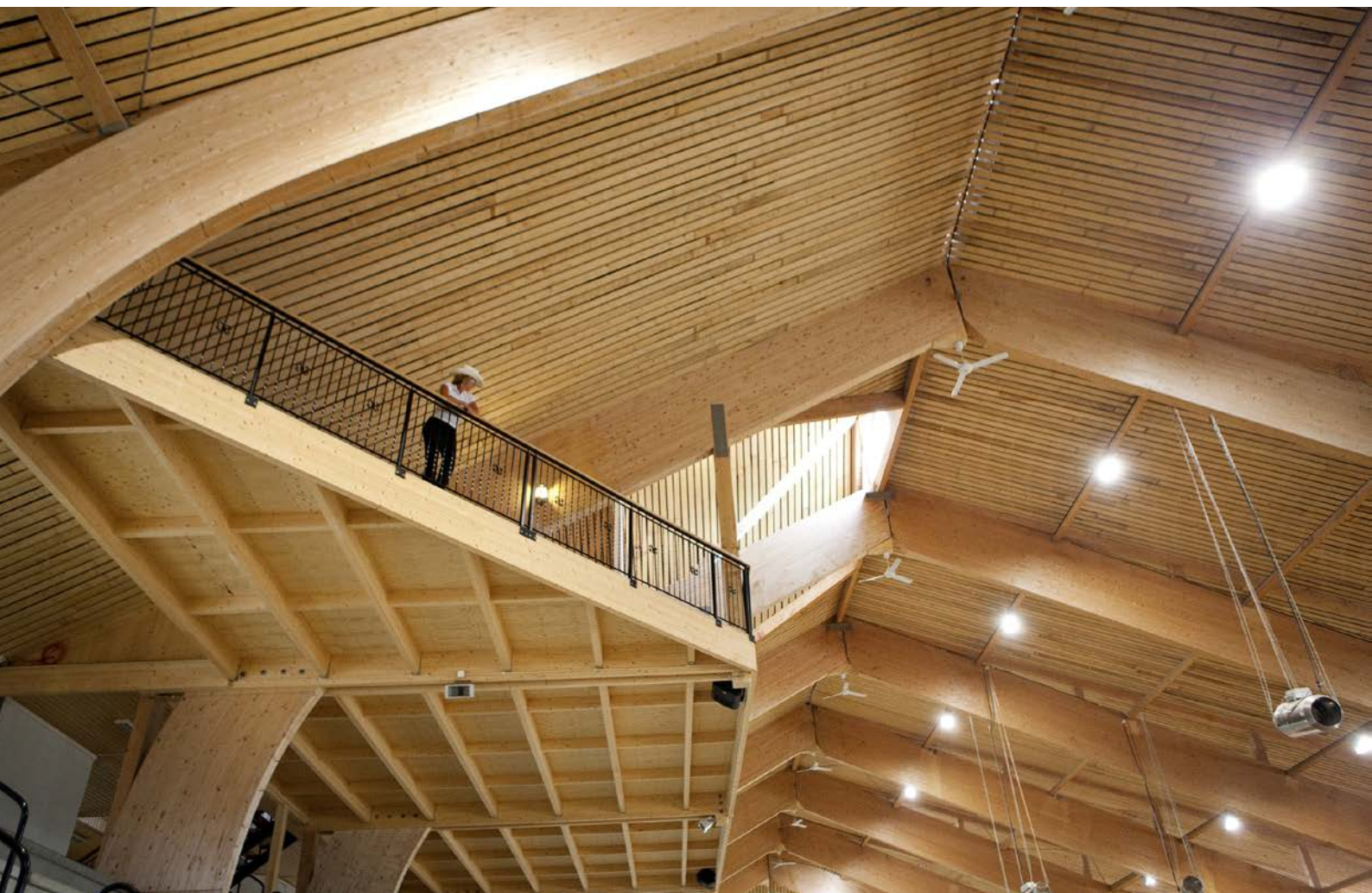

Bökeberg's riding hall.

Bending

The design bending moment capacity M_{Rd} is determined as:

$$M_{Rd} = f_{m,d} \cdot W \cdot k_{crit}$$

where:

- $f_{m,d}$ design value of bending strength.
- k_{crit} factor accounting for the effect of lateral buckling.
- W section modulus.
- $\lambda_{rel,m}$ relative slenderness ratio in bending.

$$k_{crit} = \begin{cases} 1 & \text{for } \lambda_{rel,m} \leq 0,75 \\ 1,56 - 0,75\lambda_{rel,m} & \text{for } 0,75 < \lambda_{rel,m} \leq 1,4 \\ \frac{1}{\lambda_{rel,m}^2} & \text{for } 1,4 < \lambda_{rel,m} \end{cases}$$

$$\lambda_{rel,m} = \sqrt{\frac{f_{m,k}}{\sigma_{m,crit}}}$$

where $\sigma_{m,crit}$ is the critical bending stress calculated according to the classical theory of lateral stability, using 5-percentile stiffness values (EN 1995-1-1, 6.3.3):

$$\sigma_{m,crit} = \frac{M_{y,crit}}{W_y} = \frac{\pi \sqrt{E_{0,05} I_z G_{0,05} I_{tor}}}{\ell_{ef} W_y}$$

where:

- $M_{y,crit}$ critical bending moment about the strong axis (y).
- $E_{0,05}$ 5th percentile value of modulus of elasticity parallel to grain.
- $G_{0,05}$ 5th percentile value of shear modulus parallel to grain.
- I_z second moment of area about the weak axis (z).
- I_{tor} torsional moment of inertia.
- ℓ_{ef} effective length of the beam, depending on support conditions and load configuration, see table 4.1.
- W_y section modulus about the strong axis (y).

For structural timber and glulam with rectangular cross section from softwood the critical bending stress can be taken as:

$$\sigma_{m,crit} = \frac{0,78 \cdot b^2}{h \ell_{ef}} E_{0,05}$$

Table 4.1 Effective length as a ratio of the span ¹⁾

Beam type	Loading	ℓ_{ef}/ℓ
Simply supported	Constant moment	1,0
	Uniformly distributed load	0,9
	Concentrated force at midspan	0,8
Cantilever	Uniformly distributed load	0,5
	Concentrated force at free end	0,8

¹⁾ The values in the table are valid for a beam with torsionally restrained supports and loaded at the centre of gravity of the cross section. If the load is applied at the compression edge, ℓ_{ef} should be increased $2h$, and may be decreased by $0,5h$ for a load at the tension edge.

Source: Table according to EN 1995-1-1:2004, 6.3.3.

Axial loading

5.1 Tension 22

5.2 Compression 23

5.1 Tension

The capacity $N_{t,0,Rd}$ in tension parallel to the grain is:

$$N_{t,0,Rd} = f_{t,0,d} A$$

where:

- $f_{t,0,d}$ design tension strength parallel to grain.
- A cross section area, when calculating the cross section area, cross section reductions due to for example drill-holes and slots shall be taken into account.

The capacity $N_{t,90,Rd}$ in tension perpendicular to the grain is:

$$N_{t,90,Rd} = f_{t,90,d} \cdot A \quad (\text{for structural timber})$$

$$N_{t,90,Rd} = \left(\frac{V_0}{V} \right)^{0,2} f_{t,90,d} \cdot A \quad (\text{for glulam})$$

where:

- $f_{t,90,d}$ design tension strength perpendicular to grain.
- V_0 reference volume = 0,01 m³.
- V the considered volume under tension.



Universeum, Göteborg.

5.2 Compression

The capacity $N_{c,0,Rd}$ in compression parallel to grain is:

$$N_{c,0,Rd} = f_{c,0,d} \cdot A \cdot k_c$$

$$k_c = \frac{1}{k + \sqrt{k^2 - \lambda_{rel}^2}} \quad \text{for } \lambda_{rel} > 0,3$$

$$k = 0,5 \left(1 + \beta_c (\lambda_{rel} - 0,3) + \lambda_{rel}^2 \right)$$

$$\lambda_{rel} = \frac{\lambda}{\pi} \sqrt{\frac{f_{c,0,k}}{E_{0,05}}}$$

$$\lambda = \frac{\ell_e}{i}$$

$$i = \sqrt{I/A}$$

where:

- $f_{c,0,d}$ design compression strength parallel to grain.
- $f_{c,0,k}$ characteristic compression strength parallel to grain.
- A cross section area.
- k_c, k instability factors.
- λ_{rel} relative slenderness ratio.
- λ slenderness ratio.
- $E_{0,05}$ fifth percentile value of modulus of elasticity.
- ℓ_e effective buckling length in compression.
- i radius of gyration.
- I second moment of area.

The parameter β_c accounts for initial out of straightness and can be taken to 0,2 for structural timber and 0,1 for glulam and LVL.

Cross section reductions due to for example drill-holes and slots can reduce the capacity substantially.

The capacity in compression perpendicular to grain (notice not axial loading) is:

$$N_{c,90,Rd} = k_{c,90} \cdot f_{c,90,d} \cdot A_{ef}$$

where:

- $k_{c,90}$ factor taking into account the load configuration and degree of compressive deformation (EN 1995-1-1, 6.1.5).
- $f_{c,90,d}$ design compressive strength perpendicular to grain, the design value is determined according to *Volume 1: Section 3.1.3.*
- A_{ef} effective contact area in compression perpendicular to grain.

A_{ef} should be determined on the basis of an effective contact length ℓ_{ef} parallel to the grain, where the actual contact length ℓ at each side may be increased by 30 mm, but not more than a , ℓ or $\ell_1/2$, see figure 5.1, page 24.

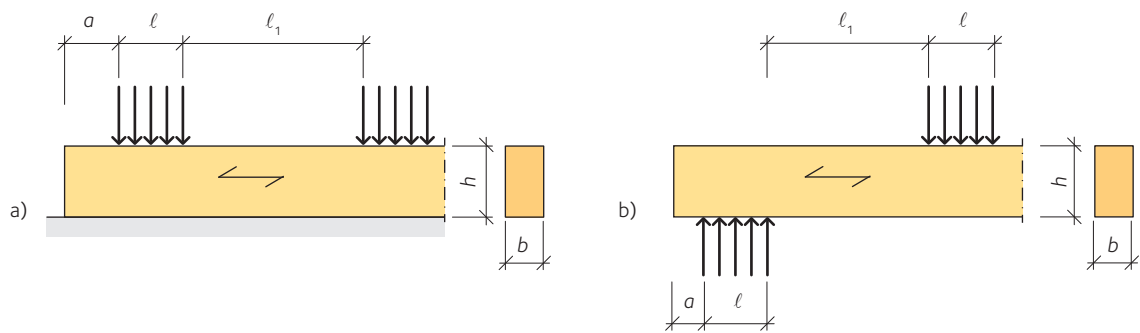

Figure 5.1 Member on a) continuous supports (for example a ground plate on a concrete slab) and b) discrete supports (for example a beam supported by columns).

For a member resting on continuous supports, provided that $\ell_1 \geq 2h$, see figure 5.1 a), the value of $k_{c,90}$ should be taken as:

$$k_{c,90} = 1,25 \text{ for structural, softwood timber}$$

$$k_{c,90} = 1,5 \text{ for glulam}$$

where ℓ , ℓ_1 and a are defined in figure 5.1, and h is the depth of the member.

For members on discrete supports loaded by distributed loads and/or concentrated loads, provided that $\ell_1 \geq 2h$, see figure 5.1 b), the value of $k_{c,90}$ should be taken as:

$$k_{c,90} = 1,5 \text{ for structural, softwood timber}$$

$$k_{c,90} = 1,75 \text{ for glulam provided that } \ell \leq 400 \text{ mm}$$

For example rafters acting at centres < 610 mm may thereby be regarded as a distributed load.

For other cases the value of $k_{c,90}$ should be taken as 1,0. Also see Volume 1: Section 3.1.3.

Cross section subjected to shear

For a rectangular cross section loaded in bending the shear capacity is determined by:

$$V_{Rd} = \frac{A \cdot f_{v,d}}{1,5}$$

where:

$f_{v,d}$ design shear strength for the actual condition.

For verification of shear resistance for members in bending, the influence of cracks is considered by using an effective width b_{ef} of the member given by:

$$b_{ef} = k_{cr} \cdot b$$

where:

b width of the member in the considered section.

$k_{cr} = 0,67$ for structural timber and glulam.

$k_{cr} = 1,0$ for other wood-based products in accordance with EN 13986 and EN 14374, for example LVL.

$f_{v,k}$ characteristic shear strength in MPa.

For possible shear force reduction at supports, see EN 1995-1-1, 6.1.7 (3).

For cross sections subjected to torsion, see EN 1995-1-1, 6.1.8.



Riding hall Smedstad, Linköping.

Cross section subjected to combined stresses

- 7.1 Compression stresses at an angle to the grain 26
- 7.2 Combined bending and axial tension 26
- 7.3 Combined bending and axial compression 27

7.1 Compression stresses at an angle to the grain

The compressive stresses $\sigma_{c,\alpha,d}$ at an angle α to the grain, see figure 7.1, should satisfy the following expression:

$$\sigma_{c,\alpha,d} \leq \frac{f_{c,0,d}}{\frac{f_{c,0,d}}{k_{c,90} \cdot f_{c,90,d}} \sin^2 \alpha + \cos^2 \alpha}$$

where:

- $f_{c,0,d}$ design compressive strength parallel to grain.
- $f_{c,90,d}$ design compressive strength perpendicular to grain.
- $k_{c,90}$ factor taking into account effect of stress perpendicular to grain, see section 5.2, page 23..

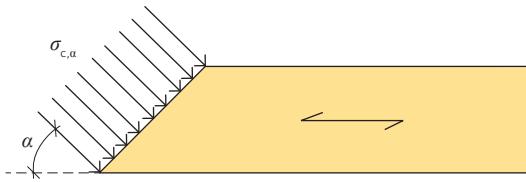

Figure 7.1 Compressive stresses at an angle to the grain

7.2 Combined bending and axial tension

In combined bending and tension the following expression shall be satisfied:

$$\frac{M_{y,Ed}}{M_{y,Rd}} + k_m \frac{M_{z,Ed}}{M_{z,Rd}} + \frac{N_{t,0,Ed}}{N_{t,0,Rd}} \leq 1$$

$$k_m \frac{M_{y,Ed}}{M_{y,Rd}} + \frac{M_{z,Ed}}{M_{z,Rd}} + \frac{N_{t,0,Ed}}{N_{t,0,Rd}} \leq 1$$

where:

- $M_{y,Ed}, M_{z,Ed}$ design load effect from bending moments about the principal axes y and z respectively.
- $N_{t,0,Ed}$ design load effect from axial tension.
- $M_{y,Rd}, M_{z,Rd}$ design load capacity in bending about the principal axes y and z respectively.
- $N_{t,0,Rd}$ design load capacity in axial tension.
- k_m reduction factor = 0,7 for rectangular cross sections and = 1,0 for other types of cross sections.

7.3 Combined bending and axial compression

In **combined bending and compression without risk for buckling**, that is if $\lambda_{rel} \leq 0,3$, the following expression shall be satisfied:

$$\frac{M_{y,Ed}}{M_{y,Rd}} + k_m \frac{M_{z,Ed}}{M_{z,Rd}} + \left(\frac{N_{c,0,Ed}}{N_{c,0,Rd}} \right)^2 \leq 1$$

$$k_m \frac{M_{y,Ed}}{M_{y,Rd}} + \frac{M_{z,Ed}}{M_{z,Rd}} + \left(\frac{N_{c,0,Ed}}{N_{c,0,Rd}} \right)^2 \leq 1$$

where:

- $M_{y,Ed}, M_{z,Ed}$ design load effect from bending moments about the principal axes y and z respectively.
- $N_{c,0,Ed}$ design load effect from axial compression.
- $M_{y,Rd}, M_{z,Rd}$ design load capacity in bending about the principal axes y and z respectively.
- $N_{c,0,Rd}$ design load capacity in axial compression.
- k_m reduction factor = 0,7 for rectangular cross sections and = 1,0 for other types of cross sections.

In **combined bending and compression with risk for buckling**, that is if $\lambda_{rel} > 0,3$, the following expression shall be satisfied:

$$\frac{M_{y,Ed}}{M_{y,Rd}} + k_m \frac{M_{z,Ed}}{M_{z,Rd}} + \frac{N_{c,0,Ed}}{k_{c,y} N_{c,0,Rd}} \leq 1$$

$$k_m \frac{M_{y,Ed}}{M_{y,Rd}} + \frac{M_{z,Ed}}{M_{z,Rd}} + \frac{N_{c,0,Ed}}{k_{c,z} N_{c,0,Rd}} \leq 1$$

For taking into account simultaneous lateral buckling and buckling, see Chapter 4, page 21, respectively section 5.2, page 23, in this volume (Volume 2) for factor k_{crit} respectively k_c and also see EN 1995-1-1, 6.3.3 (6).



Linköping's Library.

Members with varying cross section or curved shape

- 8.1 Tapered beams 28
- 8.2 Double tapered, curved and pitched cambered beams 29
- 8.3 Notched members 31

8.1 Tapered beams

The stresses $\sigma_{m,\alpha,d}$ at the tapered edge of a beam with rectangular cross section $b \times h$ should satisfy the following condition:

$$\sigma_{m,\alpha,d} = \frac{6M_d}{bh^2} \leq k_{m,\alpha} \cdot f_{m,d}$$

where:

- M_d design bending moment.
- $f_{m,d}$ design bending strength.
- $f_{v,d}$ design shear strength.
- $f_{t,90,d}$ design tensile strength perpendicular to grain.
- $k_{m,\alpha}$ reduction factor described below.

For tensile stresses parallel to the tapered edge:

$$k_{m,\alpha} = \frac{1}{\sqrt{1 + \left(\frac{f_{m,d}}{0,75 f_{v,d}} \tan \alpha\right)^2 + \left(\frac{f_{m,d}}{f_{t,90,d}} \tan^2 \alpha\right)^2}}$$

For compressive stresses parallel to the tapered edge:

$$k_{m,\alpha} = \frac{1}{\sqrt{1 + \left(\frac{f_{m,d}}{1,5 f_{v,d}} \tan \alpha\right)^2 + \left(\frac{f_{m,d}}{f_{c,90,d}} \tan^2 \alpha\right)^2}}$$

The above condition shall be satisfied for single tapered beams and for double tapered beams in the parts which have a single taper with angle α , see figure 8.1.

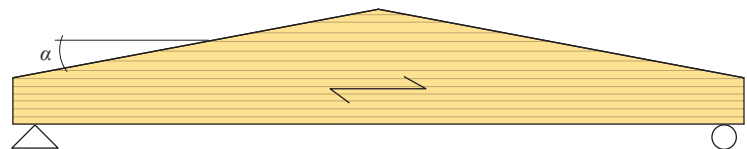

Figure 8.1 Double tapered beam

8.2 Double tapered, curved and pitched cambered beams

The stress from a bending moment $M_{\text{ap,d}}$ in the apex zone, *see figure 8.2, page 30*, shall satisfy the following condition:

$$\sigma_{\text{m,d}} = k_{\ell} \frac{6M_{\text{ap,d}}}{bh_{\text{ap}}^2} \leq k_{\text{r}} f_{\text{m,d}}$$

with:

$$k_{\ell} = k_1 + k_2 \left(\frac{h_{\text{ap}}}{r} \right) + k_3 \left(\frac{h_{\text{ap}}}{r} \right)^2 + k_4 \left(\frac{h_{\text{ap}}}{r} \right)^3$$

$$k_1 = 1 + 1,4 \tan \alpha_{\text{ap}} + 5,4 \tan^2 \alpha_{\text{ap}}$$

$$k_2 = 0,35 - 8 \tan \alpha_{\text{ap}}$$

$$k_3 = 0,6 + 8,3 \tan \alpha_{\text{ap}} - 7,8 \tan^2 \alpha_{\text{ap}}$$

$$k_4 = 6 \tan^2 \alpha_{\text{ap}}$$

$$r = r_{\text{in}} + 0,5h_{\text{ap}}$$

$$k_{\text{r}} = 1,0$$

$$k_{\text{r}} = \begin{cases} 1 & \text{for } \frac{r_{\text{in}}}{t} \geq 240 \quad (\text{double tapered beams}) \\ 0,76 + 0,001 \frac{r_{\text{in}}}{t} & \text{for } \frac{r_{\text{in}}}{t} < 240 \quad (\text{curved and pitched cambered beams}) \end{cases}$$

where:

- k_{ℓ} correction factor, *see above*.
- b width of the beam.
- h_{ap} depth of the beam at the apex, *see figure 8.2, page 30*.
- k_{r} reduction factor accounting for the lamination curvature.
- α_{ap} inclination of the surface at the apex, *see figure 8.2, page 30*.
- r_{in} inner radius, *see figure 8.2, page 30*.
- t glulam lamination thickness.

In the apex zone the largest tensile stress perpendicular to grain $\sigma_{\text{t,90,d}}$ should satisfy the following condition:

$$\sigma_{\text{t,90,d}} \leq k_{\text{dis}} \cdot k_{\text{vol}} \cdot f_{\text{t,90,d}}$$

with:

$$k_{\text{vol}} = \left(\frac{V_0}{V} \right)^{0,2} \quad \text{for glulam and LVL with all veneers parallel to the beam axis.}$$

$$k_{\text{dis}} = 1,4 \quad \text{for double tapered and curved beams.}$$

$$k_{\text{dis}} = 1,7 \quad \text{for pitched cambered beams.}$$



Public bath Sanna, Kristinehamn.



Göransson Arena, Sandviken.

where:

- k_{dis} factor accounting for the effect of stress distribution in the apex zone.
 - k_{vol} volume factor.
 - $f_{t,90,d}$ design tensile strength perpendicular to grain.
 - V_0 reference volume 0,01 m³.
 - V stressed volume of the apex zone in m³, see figure 8.2, not greater than 2/3 of the total volume of the beam.
- See calculation formulas in *Volume 1: Table 3.4.*

The largest tensile stress $\sigma_{t,90,d}$ perpendicular to grain due to bending moment can be calculated as:

$$\sigma_{t,90,d} = k_p \frac{6M_{ap,d}}{bh_{ap}^2}$$

where:

- $M_{ap,d}$ design moment giving tensile stress parallel to the inner curved edge.
- k_p correction factor, see below.

$$k_p = k_5 + k_6 \left(\frac{h_{ap}}{r} \right) + k_7 \left(\frac{h_{ap}}{r} \right)^2$$

$$k_5 = 0,2 \tan \alpha_{ap}$$

$$k_6 = 0,25 - 1,5 \tan \alpha_{ap} + 2,6 \tan^2 \alpha_{ap}$$

$$k_7 = 2,1 \cdot \tan \alpha_{ap} - 4 \cdot \tan^2 \alpha_{ap}$$

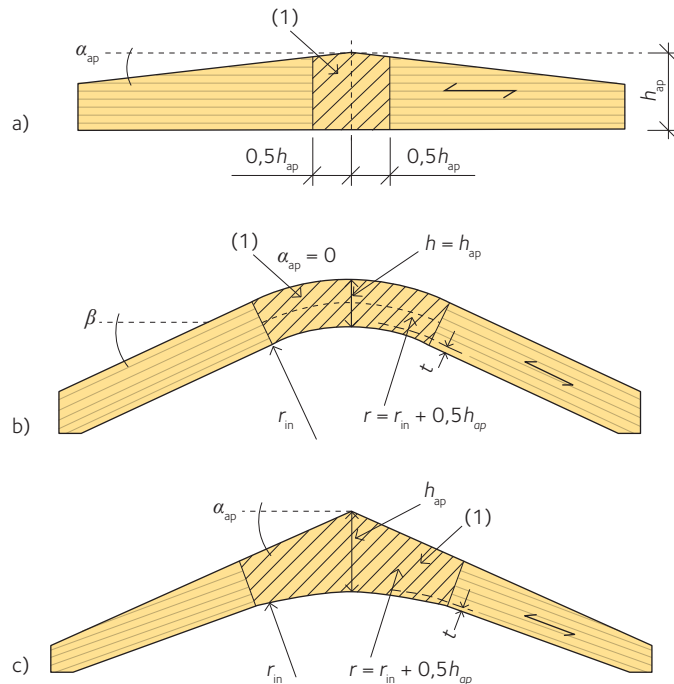

Figure 8.2 a) Double tapered, b) curved and c) pitched cambered beams. Fibre direction parallel to the lower edge. The part marked (1) in the figure is the stressed/curved volume V .

8.3 Notched members

For notched beams with rectangular cross sections where the grain direction is essentially parallel to the longitudinal axis of the member, the effective shear stress τ_d at the notched support should satisfy the following condition:

$$\tau_d = \frac{1,5V_d}{b_{ef}h_{ef}} \leq k_v f_{v,d}$$

where:

- h_{ef} effective depth as shown in figure 8.3.
- V_d design shear force.
- b_{ef} effective width of cross section, according to section 6, page 25.
- k_v reduction factor, see below.
- $f_{v,d}$ design shear strength.

For beams notched at the opposite side of the support, see figure 8.3 b), $k_v = 1,0$.

For beams notched on the same side as the support, see figure 8.3 a):

$$k_v = \min \left\{ \begin{array}{l} 1 \\ \frac{k_n \left(1 + \frac{1,1 \cdot i^{1,5}}{\sqrt{h}} \right)}{\sqrt{h} \left(\sqrt{\alpha(1-\alpha)} + 0,8 \frac{x}{h} \sqrt{\frac{1}{\alpha} - \alpha^2} \right)} \end{array} \right.$$

where:

- i notch inclination, see figure 8.3 a).
- h beam depth, in mm.
- x distance from line of action of support to the corner of the notch, figure 8.3 a).

$$\alpha = \frac{h_{ef}}{h}$$

$$k_n = \begin{cases} 4,5 & \text{(for LVL)} \\ 5 & \text{(for structural timber)} \\ 6,5 & \text{(for glulam)} \end{cases}$$

Notice that possible shear force reduction is only allowed in case b).

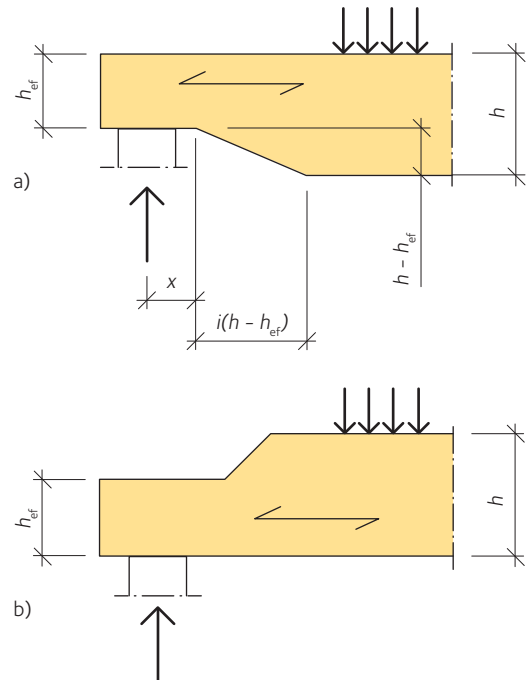

Figure 8.3 End-notched beams

Serviceability limit states, SLS

- 9.1 General 32
- 9.2 Joint slip 33
- 9.3 Deflections 34
- 9.4 Vibrations 35

9.1 General

Calculation of deflections is usually based on mean values for stiffness properties. Time dependence may be considered by defining a final modulus of elasticity $E_{\text{mean,fin}}$ as:

$$E_{\text{mean,fin}} = \frac{E_{\text{mean}}}{1 + k_{\text{def}}}$$

where E_{mean} is the mean value of the modulus of elasticity and k_{def} accounts for moisture effects on deformation, according to *table 9.1*.

Table 9.1 Values of k_{def} for timber and wood-based materials

Material	Associated material standard	Service class		
		1	2	3
Structural timber	EN 14081-1	0,60	0,80	2,00
Glulam	EN 14080	0,60	0,80	2,00
LVL	EN 14374, EN 14279	0,60	0,80	2,00
Plywood	EN 636			
	Type 1	0,80	-	-
	Type 2	0,80	1,00	-
	Type 3	0,80	1,00	2,50
OSB	EN 300			
	OSB/2	2,25	-	-
	OSB/3, OSB/4	1,50	2,25	-
Particleboard	EN 312			
	Type P4	2,25	-	-
	Type P5	2,25	3,00	-
	Type P6	1,50	-	-
	Type P7	1,50	2,25	-
Fibreboard, hard	EN 622-2			
	HB.LA	2,25	-	-
	HB.HLA1, HB.HLA2	2,25	3,00	-
Fibreboard medium	EN 622-3			
	MBH.LA1, MBH.LA2	3,00	-	-
	MBH.HLS1, MBH.HLS2	3,00	4,00	-
Fibreboard, MDF	EN 622-5			
	MDF.LA	2,25	-	-
	MDF.HLS	2,25	3,00	-

Source: Table according to EN 1995-1-1:2004, 3.1.4.

9.2 Joint slip

For joints with dowel-type fasteners the slip modulus per shear plane and per fastener can be determined from *table 9.2*.

Table 9.2 Slip modulus K_{ser} for fasteners and connectors in timber-to-timber and wood panel-to-timber connections

Fastener type	K_{ser} (N/mm)
Dowels	$\rho_m^{1.5} d / 23$
Bolts with or without clearance ¹⁾	
Screws	
Nails (with pre-drilling)	
Nails (without pre-drilling)	$\rho_m^{1.5} d^{0.8} / 30$
Staples	$\rho_m^{1.5} d^{0.8} / 80$
Split-ring connectors type A	$\rho_m d_c / 2$
Shear-plate connectors type B	
Toothed-plate connectors	
- type C1-C9	$1,5 \rho_m d_c / 4$
- type C10 and C11	$\rho_m d_c / 2$

¹⁾ The clearance should be added separately to the slip of the fastener.

Source: Table according to EN 1995-1-1:2004, 7.1.

where:

- ρ_m mean density of involved wood material, in kg/m³.
- d fastener outer diameter, in mm.
- d_c connector diameter, as defined in EN 13271.

If the mean densities $\rho_{m,1}$ and $\rho_{m,2}$ of two jointed members are different, then ρ_m in *table 9.2* should be taken as:

$$\rho_m = \sqrt{\rho_{m,1} \rho_{m,2}}$$



Public bath Holje, Olofström.

9.3 Deflections

Control of deflection w can be based on different load combinations defined in EN 1990. The total net deflection $w_{\text{net,fin}}$ after long time is given as:

$$w_{\text{net,fin}} = w_{\text{inst}} + w_{\text{creep}} - w_c = w_{\text{fin}} - w_c$$

where:

- w_{inst} instantaneous deflection based on relevant combination of loads.
- w_{creep} deflection due to creep.
- w_c precamber (if applied).
- w_{fin} final deflection due to design load.

The various components are shown in figure 9.1.

The creep deflection w_{creep} is calculated as:

$$w_{\text{creep}} = k_{\text{def}} \cdot w_{\text{inst,qp}}$$

where $w_{\text{inst,qp}}$ is the instantaneous deflection due to the quasi-permanent combination of the relevant loads.

The deflection limits given in table 9.3 are recommended in EN 1995-1-1.

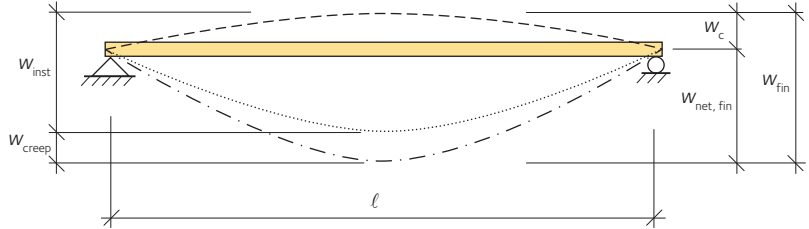

Figure 9.1 Definitions of deflection

Table 9.3 Examples of limiting values for deflections of beams (EN 1995-1-1, 7.2)

This is a Nationally Determined Parameter (NDP). In the UK, refer to BS NA EN1995-1-1, the UK national Annex to EN 1995-1-1 (Eurocode 5).

	w_{inst}	$w_{\text{net,fin}}$	w_{fin}
Beam on two supports	$l/300 - l/500$	$l/250 - l/350$	$l/150 - l/300$
Cantilever beam	$l/150 - l/250$	$l/125 - l/175$	$l/75 - l/150$

Source: Table according to EN 1995-1-1:2004, 7.2.

9.4 Vibrations

For residential floors with a fundamental frequency lower than or equal 8 Hz ($f_1 \leq 8$ Hz) a special investigation should be made. For residential floors with a fundamental frequency higher than 8 Hz ($f_1 > 8$ Hz) the following requirements should be satisfied::

$$\frac{w}{F} \leq a \quad [\text{mm/kN}]$$

$$v \leq b^{(f_1 \zeta^{-1})} \quad [\text{m/Ns}^2]$$

where:

- w instantaneous maximum vertical deflection caused by a concentrated static force F applied at any point on the floor taking into account load distribution.
- v unit impulse velocity response, which is the initial value of vertical floor velocity caused by a unit impulse of 1 Ns applied at any point of the floor.
- ζ modal damping ratio (a typical value for timber floors can be 0,01).
- f_1 fundamental frequency of the floor.

For a simply supported rectangular floor with timber beams having a span ℓ , f_1 and v may be calculated as:

$$f_1 = \frac{\pi}{2\ell^2} \sqrt{\frac{(EI)_\ell}{m}}$$

$$v = \frac{4(0,4 + 0,6n_{40})}{mB\ell + 200}$$

where:

- m mass per unit area, in kg/m^2 .
- ℓ floor span, in m.
- $(EI)_\ell$ equivalent plate bending stiffness about an axis perpendicular to the primary beam direction, in Nm^2/m .
- n_{40} the number of first order modes with natural frequencies up to 40 Hz.
- B floor width, in m, notice is written b in EN 1995-1-1 and not to be mixed up with b above.

The value of n_{40} may be calculated from:

$$n_{40} = \left\{ \left[\left(\frac{40}{f_1} \right)^2 - 1 \right] \left(\frac{B}{\ell} \right)^4 \frac{(EI)_\ell}{(EI)_B} \right\}^{0,25}$$

where:

- $(EI)_B$ equivalent plate bending stiffness of the floor about an axis parallel to the beams, assuming $(EI)_B < (EI)_\ell$.

Connections with metal fasteners

- 10.1 General 36
- 10.2 Shear capacity of wood-wood and panel-wood connections 36
- 10.3 Shear capacity of steel-to-wood connections 38
- 10.4 Nailed connections 40
 - 10.4.1 Laterally loaded nails 40
 - 10.4.2 Requirements for spacing, distance and penetration depth 41
 - 10.4.3 Axially loaded nails 43
 - 10.4.4 Combined lateral and axial loading 44
- 10.5 Bolted and dowelled connections 44
- 10.6 Screwed connections 46
 - 10.6.1 Laterally loaded screws 46
 - 10.6.2 Axially loaded screws 46

10.1 General

The design capacity F_{Rd} of a wood connection in the ultimate limit state is generally given as:

$$F_{Rd} = k_{mod} \frac{F_{Rk}}{\gamma_M}$$

where:

- F_{Rd} total design capacity of the connection.
- F_{Rk} total characteristic capacity of the connection.
- γ_M partial coefficient for material according to *table 3.1, page 7*.
- k_{mod} strength modification factor for the relevant wood material according to *table 3.2, page 8*.

For taking into account block shear failure and plug shear failure, see *Volume 1: Section 4.9.3* and *EN 1995-1-1, Annex A* respectively.

10.2 Shear capacity of wood-wood and panel-wood connections

Characteristic load capacity for nails, staples, bolts, dowels and screws per shear plane and per fastener, is the minimum value obtained from the following expressions answering to different failure modes:

Fasteners in single shear, see *figure 10.1, page 37*:

$$F_{v,Rk} = \min \left\{ \begin{array}{ll} f_{h,1,k} t_1 d & \text{a)} \\ f_{h,2,k} t_2 d & \text{b)} \\ \frac{f_{h,1,k} t_1 d}{1 + \beta} \left[\sqrt{\beta + 2\beta^2 \left[1 + \frac{t_2}{t_1} + \left(\frac{t_2}{t_1} \right)^2 \right] + \beta^3 \left(\frac{t_2}{t_1} \right)^2} - \beta \left(1 + \frac{t_2}{t_1} \right) \right] + \frac{F_{ax,Rk}}{4} & \text{c)} \\ 1,05 \frac{f_{h,1,k} t_1 d}{2 + \beta} \left[\sqrt{2\beta(1 + \beta) + \frac{4\beta(2 + \beta) M_{y,Rk}}{f_{h,1,k} d t_1^2}} - \beta \right] + \frac{F_{ax,Rk}}{4} & \text{d)} \\ 1,05 \frac{f_{h,1,k} t_2 d}{1 + 2\beta} \left[\sqrt{2\beta^2(1 + \beta) + \frac{4\beta(1 + 2\beta) M_{y,Rk}}{f_{h,1,k} d t_2^2}} - \beta \right] + \frac{F_{ax,Rk}}{4} & \text{e)} \\ 1,15 \sqrt{\frac{2\beta}{1 + \beta}} \sqrt{2 M_{y,Rk} f_{h,1,k} d} + \frac{F_{ax,Rk}}{4} & \text{f)} \end{array} \right.$$

Fasteners in double shear, see figure 10.1:

$$F_{v,Rk} = \min \left\{ \begin{array}{ll} f_{h,1,k} t_1 d & \text{g)} \\ 0,5 f_{h,2,k} t_2 d & \text{h)} \\ 1,05 \frac{f_{h,1,k} t_1 d}{2 + \beta} \left[\sqrt{2\beta(1 + \beta) + \frac{4\beta(2 + \beta) M_{y,Rk}}{f_{h,1,k} d t_1^2}} - \beta \right] + \frac{F_{ax,Rk}}{4} & \text{j)} \\ 1,15 \sqrt{\frac{2\beta}{1 + \beta}} \sqrt{2 M_{y,Rk} f_{h,1,k} d} + \frac{F_{ax,Rk}}{4} & \text{k)} \end{array} \right.$$

where:

$$\beta = \frac{f_{h,2,k}}{f_{h,1,k}}$$

- $F_{v,Rk}$ characteristic capacity per shear plane, per fastener.
- t_i timber or board thickness or penetration depth, $i = (1, 2)$.
- $f_{h,i,k}$ characteristic embedment strength in wood member i .
- d fastener diameter.
- $M_{y,Rk}$ characteristic yield moment in fastener.
- β ratio between embedment strengths of members.
- $F_{ax,Rk}$ characteristic withdrawal capacity of the fastener.

For single shear fasteners the value of $F_{ax,Rk}$ is taken as the lower of the capacity in the two members. The different failure modes are shown in figure 10.1.

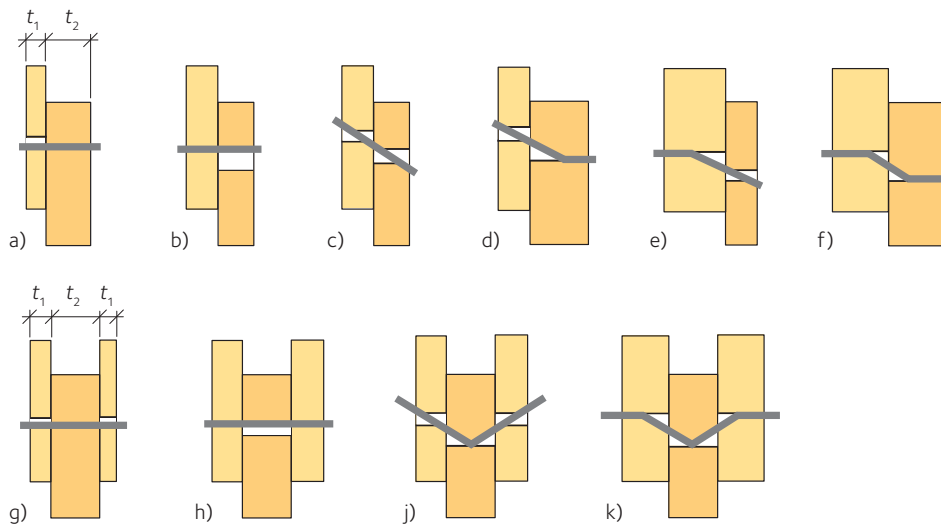

Figure 10.1 Failure modes for timber and panel connections

Top row: Single shear. Bottom row: Double shear.

The letters refer to the respective design expression above.



Warehouse for building products, Uddevalla.

The contribution $F_{ax,Rk}/4$ (rope effect) should not exceed the following percentages of the remaining capacity (based on yield theory), described by the first term in the right part in each of the equations c), d), e), f), j) and k) above:

- round nails: 15 %
- square and grooved nails: 25 %
- other nails: 50 %
- screws: 100 %
- bolts: 25 %
- dowels: 0 %

10.3 Shear capacity of steel-to-wood connections

Characteristic load capacity for nails, bolts, dowels and screws per shear plane and per fastener, is the minimum value obtained from the following expressions answering to different failure modes:

Thin steel plate (thickness $\leq 0,5 d$) in single shear:

$$F_{v,Rk} = \min \begin{cases} 0,4 f_{h,k} t_1 d & \text{a)} \\ 1,15 \sqrt{2 M_{y,Rk} f_{h,k} d} + \frac{F_{ax,Rk}}{4} & \text{b)} \end{cases}$$

Thick steel plate (thickness $\geq d$, hole diameter tolerance $\leq 0,1 d$) in single shear:

$$F_{v,Rk} = \min \begin{cases} f_{h,k} t_1 d & \text{c)} \\ f_{h,k} t_1 d \left[\sqrt{2 + \frac{4 M_{y,Rk}}{f_{h,k} d t_1^2}} - 1 \right] + \frac{F_{ax,Rk}}{4} & \text{d)} \\ 2,3 \sqrt{M_{y,Rk} f_{h,k} d} + \frac{F_{ax,Rk}}{4} & \text{e)} \end{cases}$$

Steel plate with any thickness as central member of a double shear connection:

$$F_{v,Rk} = \min \begin{cases} f_{h,l,k} t_1 d & \text{f)} \\ f_{h,l,k} t_1 d \left[\sqrt{2 + \frac{4 M_{y,Rk}}{f_{h,l,k} d t_1^2}} - 1 \right] + \frac{F_{ax,Rk}}{4} & \text{g)} \\ 2,3 \sqrt{M_{y,Rk} f_{h,l,k} d} + \frac{F_{ax,Rk}}{4} & \text{h)} \end{cases}$$

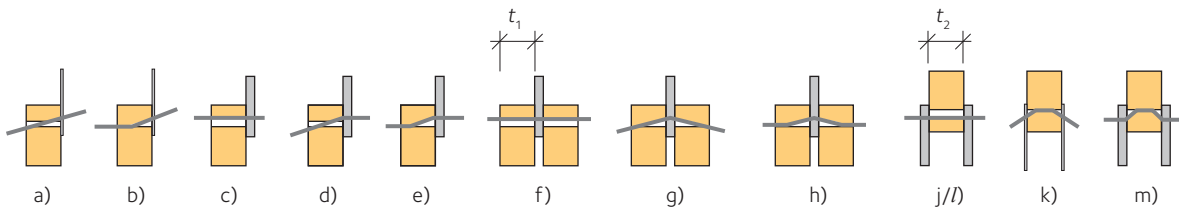

Figure 10.2 Failure modes for steel-to-timber connections. The letters refer to the respective design expression above.

Thin steel plates (thickness $\leq 0,5 d$) as outer members of a double shear connection:

$$F_{v,Rk} = \min \begin{cases} 0,5 f_{h,2,k} t_2 d & \text{j)} \\ 1,15 \sqrt{2 M_{y,Rk} f_{h,2,k} d} + \frac{F_{ax,Rk}}{4} & \text{k)} \end{cases}$$

Thick steel plates (thickness $\geq d$) as outer members of a double shear connection:

$$F_{v,Rk} = \min \begin{cases} 0,5 f_{h,2,k} t_2 d & \text{l)} \\ 2,3 \sqrt{M_{y,Rk} f_{h,2,k} d} + \frac{F_{ax,Rk}}{4} & \text{m)} \end{cases}$$

where:

- t_1 the smaller thickness of the timber side members, or the penetration depth.
- t_2 thickness of the timber middle member.

For other notations see section 10.2, page 36. The different failure modes are shown in figure 10.2. For intermediate steel plate thicknesses neither thin nor thick, the capacity can be calculated using linear interpolation with limit values for thin and thick steel plate.



Public bath, Torsby.

10.4 Nailed connections

10.4.1 Laterally loaded nails

The symbols for the thicknesses in single or double shear connections, see figure 10.3 a) and b) are defined as follows:

- t_1 Single shear connection, member thickness at the headside.
Double shear connection, minimum of headside thickness and pointside penetration.
- t_2 Single shear connection, pointside penetration.
Double shear connection, central member thickness.

For smooth nails with a minimum tensile strength of 600 MPa, the characteristic value $M_{y,Rk}$ (Nmm) for yield moment is determined by:

$$M_{y,Rk} = \frac{f_u}{600} 180d^{2,6} \quad (\text{for round nails})$$

$$M_{y,Rk} = \frac{f_u}{600} 270d^{2,6} \quad (\text{for square and grooved nails})$$

where:

- d nail diameter as defined in EN 14592, in mm, see figure 10.3 a) – c) below.
- f_u characteristic tensile strength of nail material, in MPa.

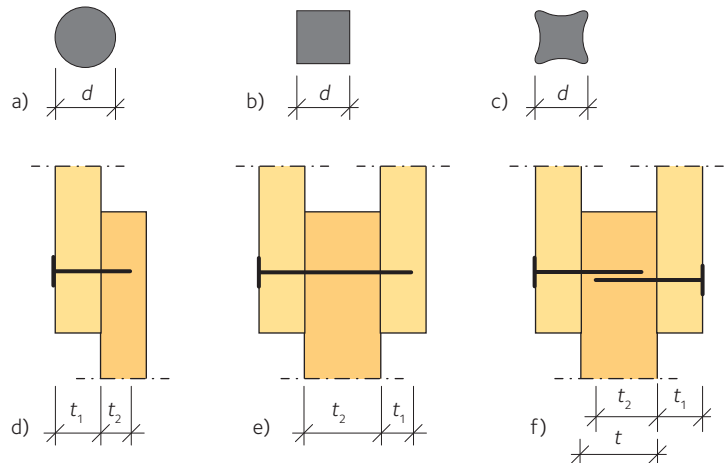

Figure 10.3 Nominal diameter d for a) round, b) square and c) grooved nail. Definition of t_1 and t_2 for d) single shear connection, e) double shear connection and f) overlapping nails.

For nails with diameter up to 8 mm, the characteristic embedment strength $f_{h,k}$ for timber and LVL is determined as:

$$f_{h,k} = 0,082 \rho_k d^{-0,3} \quad (\text{without pre-drilled holes})$$

$$f_{h,k} = 0,082(1 - 0,01d) \rho_k \quad (\text{with pre-drilled holes})$$

where:

ρ_k characteristic timber density, in kg/m^3 .
 d nail diameter, in mm.

Pre-drilling should be made if:

$$\rho_k > 500 \text{ kg/m}^3$$

$$d > 6 \text{ mm}$$

thereby the diameter of the pre-drilled hole should not exceed $0,8d$.

For nails with a head diameter of at least $2d$, the characteristic embedment strength $f_{h,k}$ for panel products are:

$$f_{h,k} = 0,11 \cdot \rho_k d^{-0,3} \quad (\text{for plywood})$$

$$f_{h,k} = 30 \cdot d^{-0,3} t^{0,6} \quad (\text{for hard fibreboard (EN 622-2)})$$

$$f_{h,k} = 65 \cdot d^{-0,7} t^{0,1} \quad (\text{for particleboard and OSB})$$

where t is panel thickness in mm, d is nail diameter in mm and ρ_k is characteristic panel density in kg/m^3 .

10.4.2 Requirements for spacing, distance and penetration depth

At least two nails are required in a connection. For smooth nails the pointside penetration depth should be at least $8d$.

In a three member connection, see Figure 10.3 f), page 40, nails may overlap in the central member provided that $t - t_2 > 4d$.

For one row of n nails parallel to grain, the load carrying capacity parallel to grain should be calculated using an effective number of fasteners n_{ef} according to:

$$n_{\text{ef}} = n^{k_{\text{ef}}}$$

where:

n number of nails in the row.

k_{ef} see table 10.1.

If the nails are displaced transversely at least $1d$ the capacity does not have to be reduced.

Table 10.1 Values of k_{ef}

Spacing ¹⁾	k_{ef}	
	Without pre-drilling	With pre-drilling
$a_1 \geq 14d$	1,0	1,0
$a_1 = 10d$	0,85	0,85
$a_1 = 7d$	0,7	0,7
$a_1 = 5d$	-	0,5

¹⁾ Linear interpolation permitted.

Source: Table according to EN 1995-1-1:2004, 8.3.1.1.

Table 10.2 Minimum values of spacing and end and edge distances for nails in wood-to-wood connections.

This is a Nationally Determined Parameter (NDP). In the UK, refer to BS NA EN1995-1-1, the UK national Annex to EN 1995-1-1 (Eurocode 5).

Spacing and end/edge distances	Angle α	Minimum spacing or distance		
		Without pre-drilled holes		Pre-drilled holes
		$\rho_k \leq 420 \text{ kg/m}^3$	$420 \text{ kg/m}^3 < \rho_k \leq 500 \text{ kg/m}^3$	
a_1 (parallel to grain)	$0^\circ \leq \alpha \leq 360^\circ$	$d < 5 \text{ mm:}$ $(5 + 5 \cos \alpha)d$ $d \geq 5 \text{ mm:}$ $(5 + 7 \cos \alpha)d$	$(7 + 8 \cos \alpha)d$	$(4 + \cos \alpha)d$
a_2 (perpendicular to grain)	$0^\circ \leq \alpha \leq 360^\circ$	$5d$	$7d$	$(3 + \sin \alpha)d$
$a_{3,t}$ (loaded end)	$-90^\circ \leq \alpha \leq 90^\circ$	$(10 + 5 \cos \alpha)d$	$(15 + 5 \cos \alpha)d$	$(7 + 5 \cos \alpha)d$
$a_{3,c}$ (unloaded end)	$90^\circ \leq \alpha \leq 270^\circ$	$10d$	$15d$	$7d$
$a_{4,t}$ (loaded edge)	$0^\circ \leq \alpha \leq 180^\circ$	$d < 5 \text{ mm:}$ $(5 + 2 \sin \alpha)d$	$d < 5 \text{ mm:}$ $(7 + 2 \sin \alpha)d$	$d < 5 \text{ mm:}$ $(3 + 2 \sin \alpha)d$
		$d \geq 5 \text{ mm:}$ $(5 + 5 \sin \alpha)d$	$d \geq 5 \text{ mm:}$ $(7 + 5 \sin \alpha)d$	$d \geq 5 \text{ mm:}$ $(3 + 4 \sin \alpha)d$
$a_{4,c}$ (unloaded edge)	$180^\circ \leq \alpha \leq 360^\circ$	$5d$	$7d$	$3d$

For wood-to-wood panel connections, spacings can be reduced by a factor 0,85 (EN 1995-1-1, 8.3.1.3).

For steel-to-wood connections, spacings can be reduced by a factor 0,7 (EN 1995-1-1, 8.3.1.4). Notations are defined in figure 10.4.

Source: Table according to EN 1995-1-1:2004, 8.3.1.2.

Table 10.3 Common nail dimensions, refers to grooved nail. Nails are identified by diameter/cross dimension (mm) and length (mm).

Diameter or cross dimension (mm)	Length (mm)
1,4	25
1,7	35
2,0	40, 50, 60
2,3	50, 60
2,5	60
2,8	75
3,1	75
3,4	100
3,7	100
4,0	125
4,3	125
4,7	150
5,1	150
5,5	175
6,0	200
6,5	225
7,0	250
8,0	300

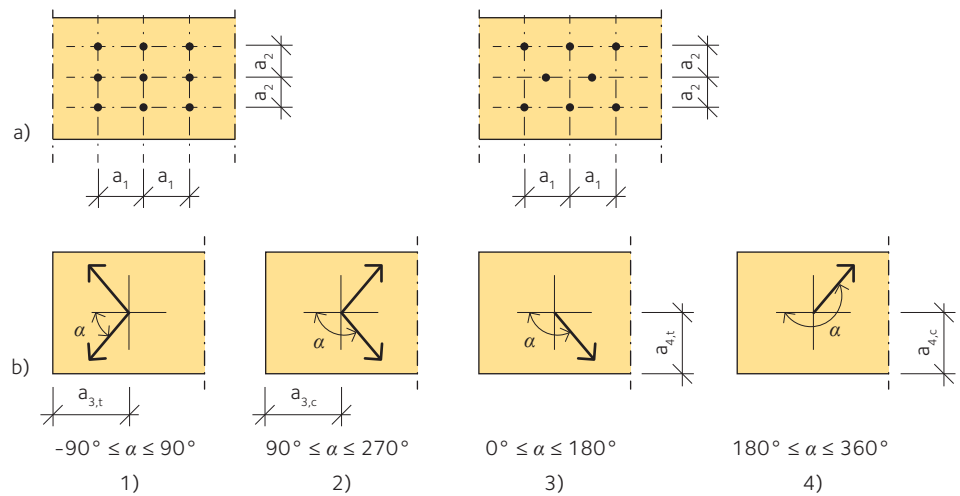

Figure 10.4 Definition of edge and end distances and spacings between fasteners

a) Spacing parallel to and perpendicular between rows,

b) edge and end distances (α is the angle between grain and force direction);

1) loaded end, 2) unloaded end, 3) loaded edge, 4) unloaded edge.

10.4.3 Axially loaded nails

- Nails used to resist permanent or long-term axial loading shall be threaded.
- Nails in end grain should be considered incapable to transmit axial load.

The characteristic withdrawal capacity of nails $F_{ax,Rk}$ for nailing perpendicular to grain, see figure 10.5 a), and slant nailing, see figure 10.5 b), is given by:

- For nails other than smooth nails (defined in EN 14592):

$$F_{ax,Rk} = \min \begin{cases} f_{ax,k} dt_{pen} \\ f_{head,k} d_h^2 \end{cases}$$

- For smooth nails:

$$F_{ax,Rk} = \min \begin{cases} f_{ax,k} dt_{pen} \\ f_{ax,k} dt + f_{head,k} d_h^2 \end{cases}$$

där:

- $f_{ax,k}$ characteristic pointside withdrawal strength.
- $f_{head,k}$ characteristic headside pull-through strength.
- d nail diameter.
- t_{pen} pointside penetration depth or length of threaded part in the pointside member.
- t thickness of headside member.
- d_h nail head diameter.

For smooth nails with a pointside penetration depth of at least $12d$, the characteristic values of the withdrawal and pull-through strengths should be found from the following expressions:

$$f_{ax,k} = 20 \cdot 10^{-6} \rho_k^2 \text{ [N/mm}^2\text{]} \quad f_{head,k} = 70 \cdot 10^{-6} \rho_k^2 \text{ [N/mm}^2\text{]}$$

where ρ_k is the characteristic timber density, in kg/m^3 .

Values of $f_{ax,k}$ and $f_{head,k}$ should be determined by tests according to EN 1382, EN 1383 and EN 14358. In practical design work these values are obtained from the Declarations of Performance, provided by the nail manufacturers.

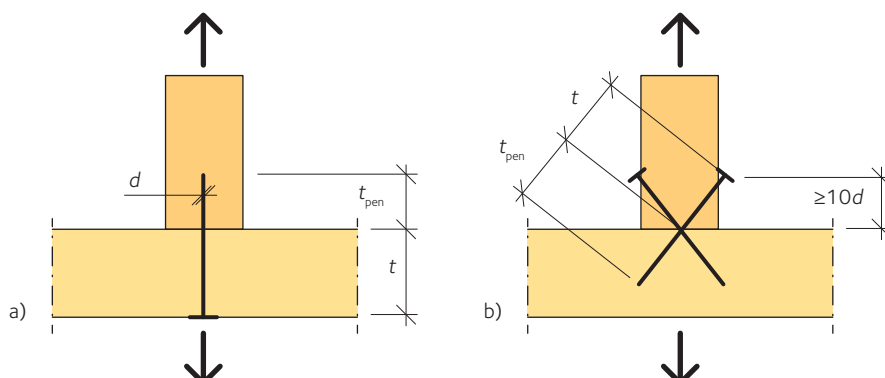

Figure 10.5 Nailing a) perpendicular to grain and b) slant nailing.



Public bath Holje, Olofström.

10.4.4 Combined lateral and axial loading

For connections subjected to a combination of axial load $F_{ax,Ed}$ and lateral load $F_{v,Ed}$ the following interaction formulas are valid:

- For smooth nails:

$$\frac{F_{ax,Ed}}{F_{ax,Rd}} + \frac{F_{v,Ed}}{F_{v,Rd}} \leq 1$$

- For other types of nails:

$$\left(\frac{F_{ax,Ed}}{F_{ax,Rd}} \right)^2 + \left(\frac{F_{v,Ed}}{F_{v,Rd}} \right)^2 \leq 1$$

where $F_{ax,Rd}$ and $F_{v,Rd}$ are the design load capacities under axial and lateral loading respectively.

10.5 Bolted and dowelled connections

Characteristic value for yield moment $M_{y,Rk}$ for bolts and dowels:

$$M_{y,Rk} = 0,3f_u d^{2,6}$$

where:

- f_u characteristic tensile strength, in MPa.
- d bolt or dowel diameter, in mm.

For $d \leq 30$ mm the characteristic embedment strength at angle α to the grain is given by:

$$f_{h,\alpha,k} = \frac{f_{h,0,k}}{k_{90} \sin^2 \alpha + \cos^2 \alpha} \quad [\text{N/mm}^2]$$

$$f_{h,0,k} = 0,082(1 - 0,01d)\rho_k \quad [\text{N/mm}^2]$$

where:

$$k_{90} = \begin{cases} 1,35 + 0,015d & \text{(for softwood)} \\ 1,30 + 0,015d & \text{(for LVL)} \\ 0,90 + 0,015d & \text{(for hardwood)} \end{cases}$$

and:

- ρ_k characteristic timber density, in kg/m^3 .
- d bolt or dowel diameter, in mm.

For one row of n bolts or dowels parallel to the grain direction, the load carrying capacity parallel to grain, should be calculated using an effective number of fasteners n_{ef} given by:

$$n_{\text{ef}} = \min \left\{ \begin{array}{l} n \\ n^{0,9} \sqrt[4]{\frac{a_1}{13d}} \end{array} \right.$$

where:

- n number of bolts or dowels in the row.
- a_1 spacing between fasteners, in mm.
- d bolt or dowel diameter, in mm.

For loads perpendicular to grain, $n_{\text{ef}} = n$ and for angles $0^\circ < \alpha < 90^\circ$ between force and grain direction, linear interpolation may be used.

For bolted or dowelled steel-to-timber connections the rules in section 10.3, page 38 are applicable.

Table 10.4 Minimum values of spacing and end and edge distances for bolts

Spacing and end/edge distances	Angle	Minimum spacing or distance
a_1 (parallel to grain)	$0^\circ \leq \alpha \leq 360^\circ$	$(4 + \cos \alpha)d$
a_2 (perpendicular to grain)	$0^\circ \leq \alpha \leq 360^\circ$	$4d$
$a_{3,t}$ (loaded end)	$-90^\circ \leq \alpha \leq 90^\circ$	$\max(7d; 80\text{mm})$
$a_{3,c}$ (unloaded end)	$90^\circ \leq \alpha < 150^\circ$	$(1 + 6 \sin \alpha)d$
	$150^\circ \leq \alpha < 210^\circ$	$4d$
	$210^\circ \leq \alpha \leq 270^\circ$	$(1 + 6 \sin \alpha)d$
$a_{4,t}$ (loaded edge)	$0^\circ \leq \alpha \leq 180^\circ$	$\max[(2 + 2 \sin \alpha)d; 3d]$
$a_{4,c}$ (unloaded edge)	$180^\circ \leq \alpha \leq 360^\circ$	$3d$

For notations, see figure 10.4, page 42.

Source: Table according to EN 1995-1-1:2004, 8.5.1.1.

Table 10.5 Minimum values of spacing and end and edge distances for dowels

Spacing and end/edge distances	Angle	Minimum spacing or distance
a_1 (parallel to grain)	$0^\circ \leq \alpha \leq 360^\circ$	$(3 + 2 \cos \alpha)d$
a_2 (perpendicular to grain)	$0^\circ \leq \alpha \leq 360^\circ$	$3d$
$a_{3,t}$ (loaded end)	$-90^\circ \leq \alpha \leq 90^\circ$	$\max(7d; 80\text{mm})$
$a_{3,c}$ (unloaded end)	$90^\circ \leq \alpha < 150^\circ$	$a_{3,t} \sin \alpha $
	$150^\circ \leq \alpha < 210^\circ$	$\max(3,5d; 40\text{mm})$
	$210^\circ \leq \alpha \leq 270^\circ$	$a_{3,t} \sin \alpha $
$a_{4,t}$ (loaded edge)	$0^\circ \leq \alpha \leq 180^\circ$	$\max[(2 + 2 \sin \alpha)d; 3d]$
$a_{4,c}$ (unloaded edge)	$180^\circ \leq \alpha \leq 360^\circ$	$3d$

For notations, see figure 10.4, page 42.

Source: Table according to EN 1995-1-1:2004/A2:2014, 8.6.

10.6 Screwed connections

10.6.1 Laterally loaded screws

For smooth shank screws the following is valid:

- The rules in *section 10.2, page 36*, can be applied provided that an effective diameter d_{ef} is used to account for the threaded part of the screw. d_{ef} shall be used when determining the yield moment capacity and the embedment strength of the threaded part. d shall be used to determine spacing, end and edge distances and the effective number of screws.
- For $d \leq 6$ mm the rules in *section 10.4.1, page 40*, and *10.4.2, page 41*, can be applied.
- For $d > 6$ mm the rules in *section 10.5, page 44*, can be applied.

If the outer thread diameter is equal to the shank diameter and the smooth shank penetrates at least $4d$ into the member containing the point of the screw, d_{ef} can be taken equal to the smooth shank diameter. Otherwise d_{ef} should be taken as 1,1 times the inner thread diameter.

10.6.2 Axially loaded screws

The resistance of an axially loaded screw connection is determined as the minimum of the following failure modes:

- withdrawal failure of the threaded part of the screw
- pull-through failure of the screw head
- tensile failure of the screw.

Failure mode 1:

The characteristic withdrawal capacity $F_{ax,\alpha,Rk}$ of a connection with axially loaded screws with $6 \text{ mm} \leq d \leq 12 \text{ mm}$ and $0,6 \leq d_1/d \leq 0,75$, can be calculated from:

$$F_{ax,\alpha,Rk} = \frac{n_{ef} f_{ax,k} d \cdot \ell_{ef} \cdot k_d}{1,2 \cos^2 \alpha + \sin^2 \alpha}$$

$$f_{ax,k} = 0,52 \cdot d^{-0,5} \ell_{ef}^{-0,1} \rho_k^{0,8}$$

$$k_d = \min \left\{ \begin{array}{l} d/8 \\ 1 \end{array} \right.$$

where:

- $f_{ax,k}$ characteristic withdrawal strength perpendicular to grain, in N/mm^2 .
- d outer thread diameter, in mm.
- d_1 inner thread diameter, in mm.
- n_{ef} effective number of screws, see below.
- ℓ_{ef} penetration length of the threaded part, in mm.
- ρ_k characteristic density of timber, in kg/m^3 .
- α angle between screw axis and grain direction, with $\alpha \geq 30^\circ$.

When the requirements for the outer and inner thread diameter are not fulfilled, it is referred to the declared values from the screw manufacturers.

Failure mode 2:

The characteristic pull-through resistance $F_{ax,\alpha,Rk}$ of a connection with axially loaded screws, can be calculated from:

$$F_{ax,\alpha,Rk} = n_{ef} \cdot f_{head,k} \cdot d_h^2 \left(\frac{\rho_k}{\rho_a} \right)^{0,8}$$

where:

$f_{head,k}$ characteristic pull-through strength for the screw according to EN 14592 for density ρ_a , see values in the Declarations of Performance provided by the screw manufacturers.

d_h diameter of the screw head, in mm.

Other notations are given above for failure mode 1.

Failure mode 3:

The characteristic tensile resistance $F_{t,Rk}$ of a connection with axially loaded screws, can be calculated from:

$$F_{t,Rk} = n_{ef} \cdot f_{tens,k}$$

where:

$f_{tens,k}$ characteristic tensile strength of the screw according to EN 14592, see values in the Declarations of Performance provided by the screw manufacturers.

For a connection with a group of n screws loaded by a force component parallel to the shank, the effective number of screws is:

$$n_{ef} = n^{0,9}$$

For combined axial and lateral loading in screwed connections the interaction expression for other types of nails in *section 10.4.4*, *page 44*, is applicable.

Table 10.6 Minimum values of spacing and end/edge distances for axially loaded screws

Minimum screw spacing parallel to grain	Minimum screw spacing perpendicular to grain	Minimum end distance to the centre of gravity of the screw in each timber member	Minimum edge distance to the centre of gravity of the screw in each timber member
a_1	a_2	$a_{1,CG}$	$a_{2,CG}$
$7d$	$5d$	$10d$	$4d$

For notations, see figure 10.6.

Source: Table according to EN 1995-1-1:2004, 8.7.2.

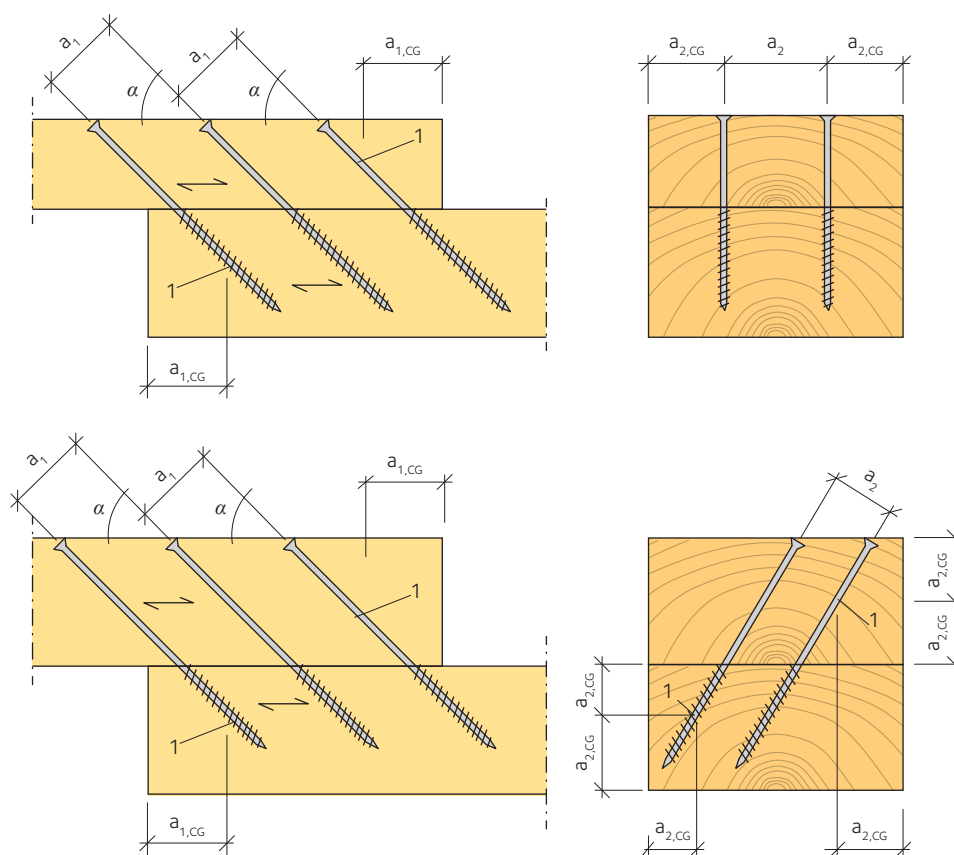

Figure 10.6 Spacing and end/edge distances for axially loaded screw connections

Key 1: Centre of gravity of the screw in each timber member.

Wall diaphragms

11.1 Simplified analysis method A

11.1 Simplified analysis method A 49

11.2 Simplified analysis method B 50

The Design method for wall diaphragms allows National Choice. For UK application refer to BS NA EN1995-1-1, the UK national Annex to EN 1995-1-1 (Eurocode 5).

Applicable only for diaphragms with tie-downs at their ends and if the width of each sheet is greater or equal than $h/4$, where h is the height of the wall, see figure 11.1. It is also assumed that the fastener spacing is constant along the perimeter of every sheathing panel.

For a wall with several wall panels the design racking load capacity $F_{v,Rd}$ is given by:

$$F_{v,Rd} = \sum_i F_{i,v,Rd}$$

where:

$F_{i,v,Rd}$ design racking load capacity of wall panel i against a force $F_{i,v,Ed}$ shown in figure 11.1:

$$F_{i,v,Rd} = \frac{F_{f,Rd} \cdot b_i \cdot c_i}{s}$$

where:

$F_{f,Rd}$ lateral design capacity of an individual fastener.
 b_i wall panel width, see figure 11.1.
 s fastener spacing (constant along the perimeter of every sheathing panel).

$$c_i = \begin{cases} 1 & \text{if } b_i \geq b_0 = h/2 \\ \frac{b_i}{b_0} & \text{if } b_i < b_0 = h/2 \end{cases}$$

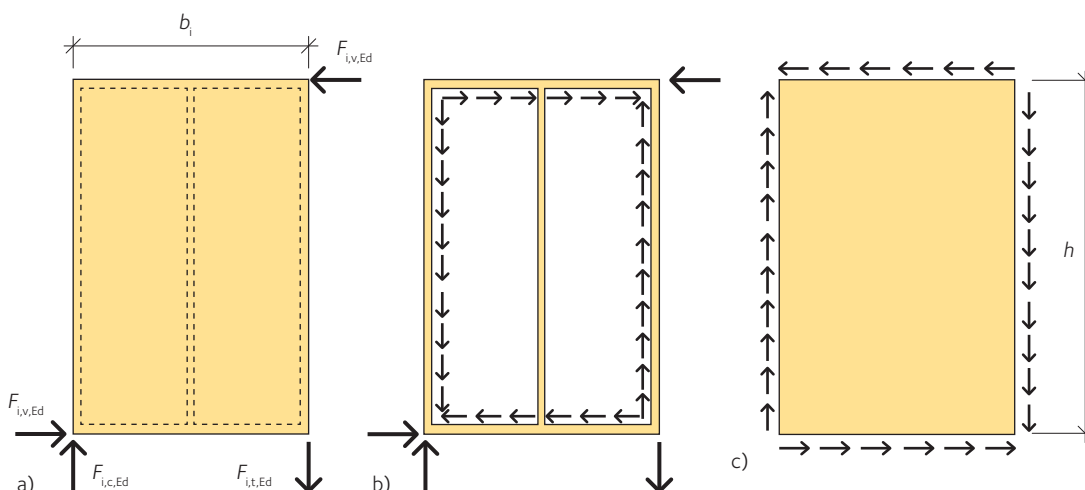

Figure 11.1 Forces acting on a) wall panel; b) framing; c) sheathing in wall diaphragm.

Wall panels containing door or window openings do not contribute to the racking capacity.

The reactions $F_{i,c,Ed}$ and $F_{i,t,Ed}$ are calculated as:

$$F_{i,c,Ed} = F_{i,t,Ed} = \frac{F_{i,v,Ed} \cdot h}{b_i}$$

11.2 Simplified analysis method B

A more general method also taking into account the capacity of wall elements with openings and the positive effect of vertical load on the wall diaphragm is described in *EN 1995-1-1, 9.2.4.3*.

Bracing

12.1 Single members in compression in compression

Each intermediate support used for bracing should have a minimum spring stiffness C determined as:

$$C = k_s \frac{N_d}{a}$$

where:

- k_s modification factor with value given in table 12.1.
- N_d mean design compressive force in the braced element.
- a bay length, see figure 12.1.

The design stabilising force F_d at each support is:

$$F_d = \begin{cases} \frac{N_d}{k_{f,1}} & \text{(for structural timber)} \\ \frac{N_d}{k_{f,2}} & \text{(for glulam and LVL)} \end{cases}$$

where $k_{f,1}$ and $k_{f,2}$ are modification factors with values given in table 12.1.

This expression can also be used for the lateral stabilising force F_d required for the compressive edge of a rectangular beam in bending if the compressive force is determined as:

$$N_d = (1 - k_{\text{crit}}) \frac{M_d}{h}$$

where:

- M_d maximum design bending moment.
- h beam depth.
- k_{crit} factor accounting for the effect of lateral buckling, see section 4, page 21.

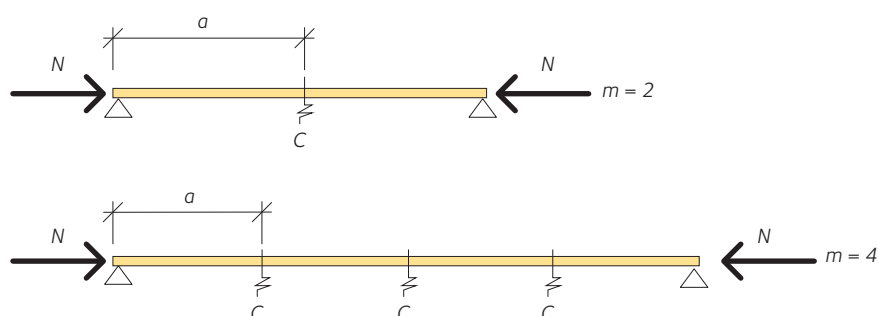

Figure 12.1 Single members in compression braced by lateral supports (C)

12.1 Single members in compression 51

12.2 Bracing of beam or truss systems 52

Table 12.1 Values of modification factors for design of bracings

This is a Nationally Determined Parameter (NDP). In the UK, refer to BS NA EN1995-1-1, the UK national Annex to EN 1995-1-1 (Eurocode 5).

Modification factor	Value
k_s	4 to 1
$k_{f,1}$	50 to 80
$k_{f,2}$	80 to 100
$k_{f,3}$	30 to 80

Source: Table according to EN 1995-1-1:2004, 9.2.5.3.

12.2 Bracing of beam or truss systems

For a series of n parallel members which together are laterally braced by a stabilizing system, see figure 12.2, the design stability load acting on the bracing system can be represented by a uniformly distributed load q_d given by:

$$q_d = k_\ell \frac{n \cdot N_d}{k_{f,3} \ell}$$

where:

$$k_\ell = \min \left\{ \begin{array}{l} 1 \\ \sqrt{\frac{15}{\ell}} \end{array} \right.$$

and:

- N_d mean design compressive force in one member.
- n number of members to be braced.
- ℓ overall span of the stabilising system, in m, see figure 12.2.
- $k_{f,3}$ modification factor with value given in table 12.1.

The horizontal deflection of the bracing system should not exceed $\ell/500$, including the influence of external loads.

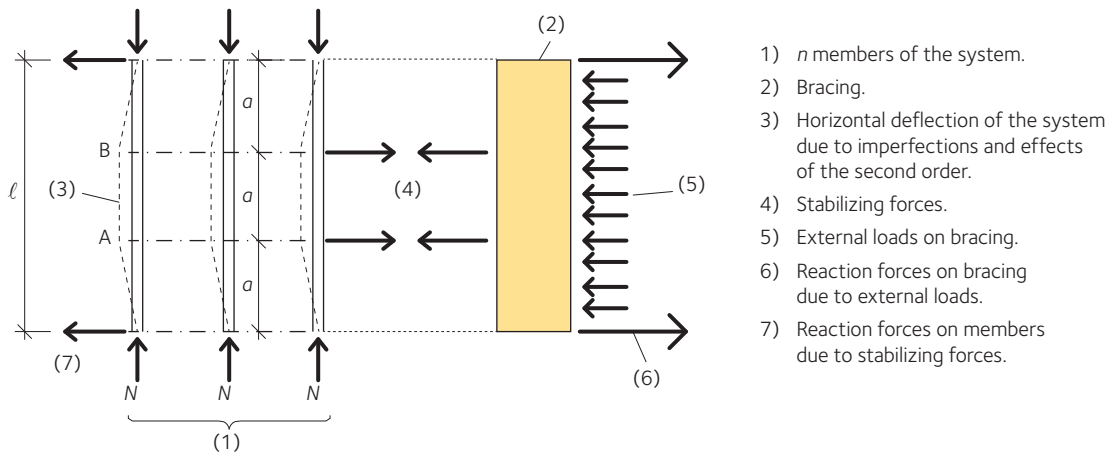

Figure 12.2 Beam or truss system supported by lateral bracing

Symbols

Symbols used in EN 1995-1-1.

Symbol	Explanation
Latin upper case letters	
A	Cross-sectional area
A_{ef}	Effective area of the total contact surface between a punched metal plate fastener and the timber; effective total contact surface perpendicular to the grain
A_f	Cross-sectional area of flange
$A_{net,t}$	Net cross-sectional area perpendicular to the grain
$A_{net,v}$	Net shear area parallel to the grain
C	Spring stiffness
$E_{0,05}$	Fifth percentile value of modulus of elasticity
E_d	Design value of modulus of elasticity
E_{mean}	Mean value of modulus of elasticity
$E_{mean,fin}$	Final mean value of modulus of elasticity
F	Force
$F_{A,Ed}$	Design force acting on a punched metal plate fastener at the centroid of the effective area
$F_{A,min,d}$	Minimum design force acting on a punched metal plate fastener at the centroid of the effective area
$F_{ax,Ed}$	Design axial force on fastener
$F_{ax,Rd}$	Design value of axial withdrawal capacity of the fastener
$F_{ax,Rk}$	Characteristic axial withdrawal capacity of the fastener
F_c	Compressive force
F_d	Design force
$F_{d,ser}$	Design force at the serviceability limit state
$F_{f,Rd}$	Design load-carrying capacity per fastener in wall diaphragm
$F_{i,c,Ed}$	Design compressive reaction force at end of shear wall
$F_{i,t,Ed}$	Design tensile reaction force at end of shear wall
$F_{i,vert,Ed}$	Vertical load on wall
$F_{i,v,Rd}$	Design racking resistance of panel i or wall i
F_{la}	Lateral load
$F_{M,Ed}$	Design force from a design moment
F_t	Tensile force
$F_{t,Rk}$	Characteristic tensile capacity of a connection
$F_{v,0,Rk}$	Characteristic load-carrying capacity of a connector along the grain
$F_{v,Ed}$	Design shear force per shear plane of fastener; Horizontal design effect on wall diaphragm

$F_{v,Rd}$	Design load-carrying capacity per shear plane per fastener; Design racking load capacity
$F_{v,Rk}$	Characteristic load-carrying capacity per shear plane per fastener
$F_{v,w,Ed}$	Design shear force acting on web
$F_{x,Ed}$	Design value of a force in x -direction
$F_{y,Ed}$	Design value of a force in y -direction
$F_{x,Rd}$	Design value of plate capacity in x -direction
$F_{y,Rd}$	Design value of plate capacity in y -direction
$F_{x,Rk}$	Characteristic plate capacity in x -direction
$F_{y,Rk}$	Characteristic plate capacity in y -direction
$G_{0,05}$	Fifth percentile value of shear modulus
G_d	Design value of shear modulus
G_{mean}	Mean value of shear modulus
H	Overall rise of a truss
I_f	Second moment of area of flange
I_{tor}	Torsional moment of inertia
I_z	Second moment of area about the weak axis
K_{ser}	Slip modulus
$K_{ser,fin}$	Final slip modulus
K_u	Instantaneous slip modulus for ultimate limit states
$L_{net,t}$	Net width of the cross-section perpendicular to the grain
$L_{net,v}$	Net length of the fracture area in shear
$M_{A,Ed}$	Design moment acting on a punched metal plate fastener
$M_{ap,d}$	Design moment at apex zone
M_d	Design moment
$M_{y,Rk}$	Characteristic yield moment of fastener
N	Axial force
$R_{90,d}$	Design splitting capacity
$R_{90,k}$	Characteristic splitting capacity
$R_{ax,d}$	Design load-carrying capacity of an axially loaded connection
$R_{ax,k}$	Characteristic load-carrying capacity of an axially loaded connection
$R_{ax,\alpha,k}$	Characteristic load-carrying capacity at an angle α to grain
R_d	Design value of a load-carrying capacity
$R_{ef,k}$	Effective characteristic load-carrying capacity of a connection
$R_{iw,d}$	Design racking capacity of a wall
R_k	Characteristic load-carrying capacity
$R_{sp,k}$	Characteristic splitting capacity

Source: EN 1995-1-1:2004, 1.6

$R_{to,k}$	Characteristic load-carrying capacity of a toothed plate connector
$R_{v,d}$	Design racking capacity of a wall diaphragm
V	Shear force; volume
V_u, V_ℓ	Shear forces in upper and lower part of beam with a hole
W_y	Section modulus about axis y
X_d	Design value of a strength property
X_k	Characteristic value of a strength property
Latin lower case letters	
a	Distance
a_1	Spacing, parallel to grain, of fasteners within one row
$a_{1,CG}$	Minimum end distance to the centre of gravity of the screw in each timber member
a_2	Spacing, perpendicular to grain, between rows of fasteners
$a_{2,CG}$	Minimum edge distance to the centre of gravity of the screw in each timber member
$a_{3,c}$	Distance between fastener and unloaded end
$a_{3,t}$	Distance between fastener and loaded end
$a_{4,c}$	Distance between fastener and unloaded edge
$a_{4,t}$	Distance between fastener and loaded edge
a_{bow}	Maximum bow of truss member
$a_{bow,perm}$	Maximum permitted bow of truss member
a_{dev}	Maximum deviation of truss
$a_{dev,perm}$	Maximum permitted deviation of truss
b	Width
b_i	Width of panel i or wall i
b_{net}	Clear distance between studs
b_w	Web width
d	Diameter; outer thread diameter
d_1	Diameter of centre hole of connector; inner thread diameter
d_c	Connector diameter
d_{ef}	Effective diameter
d_h	Head diameter of connector
$f_{h,i,k}$	Characteristic embedment strength of timber member i
$f_{a,0,0}$	Characteristic anchorage capacity per unit area for $\alpha = 0^\circ$ and $\beta = 0^\circ$
$f_{a,90,90}$	Characteristic anchorage capacity per unit area for $\alpha = 90^\circ$ and $\beta = 90^\circ$
$f_{a,\alpha,\beta,k}$	Characteristic anchorage strength
$f_{ax,k}$	Characteristic withdrawal parameter for nails
$f_{c,0,d}$	Design compressive strength along the grain
$f_{c,w,d}$	Design compressive strength of web
$f_{f,c,d}$	Design compressive strength of flange

$f_{c,90,k}$	Characteristic compressive strength perpendicular to grain
$f_{f,t,d}$	Design tensile strength of flange
$f_{h,k}$	Characteristic embedment strength
$f_{head,k}$	Characteristic pull-through parameter for nails
f_1	Fundamental frequency
$f_{m,k}$	Characteristic bending strength
$f_{m,y,d}$	Design bending strength about the principal y -axis
$f_{m,z,d}$	Design bending strength about the principal z -axis
$f_{m,\alpha,d}$	Design bending strength at an angle α to the grain
$f_{t,0,d}$	Design tensile strength along the grain
$f_{t,0,k}$	Characteristic tensile strength along the grain
$f_{t,90,d}$	Design tensile strength perpendicular to the grain
$f_{t,w,d}$	Design tensile strength of the web
$f_{u,k}$	Characteristic tensile strength of bolts
$f_{v,0,d}$	Design panel shear strength
$f_{v,\alpha,\alpha,k}$	Characteristic withdrawal strength at an angle α to grain
$f_{v,\alpha,\alpha,90,k}$	Characteristic withdrawal strength perpendicular to grain
$f_{v,d}$	Design shear strength
h	Depth; height of wall
h_{ap}	Depth of the apex zone
h_d	Hole depth
h_e	Embedment depth; loaded edge distance
h_{ef}	Effective depth
$h_{f,c}$	Depth of compression flange
$h_{f,t}$	Depth of tension flange
$h_{f,r}$	Distance from lower edge of hole to bottom of member
$h_{f,u}$	Distance from upper edge of hole to top of member
h_w	Web depth
i	Notch inclination
$k_{c,y}, k_{c,z}$	Instability factor
k_{cr}	Crack factor for shear resistance
k_{crit}	Factor used for lateral buckling
k_d	Dimension factor for panel
k_{def}	Deformation factor
k_{dis}	Factor taking into account the distribution of stresses in an apex zone
$k_{f,1}, k_{f,2}, k_{f,3}$	Modification factors for bracing resistance
k_h	Depth factor
$k_{l,q}$	Uniformly distributed load factor

Source: EN 1995-1-1:2004, 1.6

k_m	Factor considering re-distribution of bending stresses in a cross-section
k_{mod}	Modification factor for duration of load and moisture content
k_n	Sheathing material factor
k_r	Reduction factor
$k_{R,red}$	Reduction factor for load-carrying capacity
k_s	Fastener spacing factor; modification factor for spring stiffness
$k_{s,red}$	Reduction factor for spacing
k_{shape}	Factor depending on the shape of the cross-section
k_{sys}	System strength factor
k_v	Reduction factor for notched beams
k_{vol}	Volume factor
k_y eller k_z	Instability factor
$\ell_{a,min}$	Minimum anchorage length for a glued-in rod
ℓ	Span; contact length
ℓ_A	Distance from a hole to the centre of the member support
ℓ_{ef}	Effective length; Effective length of distribution
ℓ_V	Distance from a hole to the end of the member
ℓ_z	Spacing between holes
m	Mass per unit area
n_{40}	Number of frequencies below 40 Hz
n_{ef}	Effective number of fasteners
p_d	Distributed load
q_i	Equivalent uniformly distributed load
r	Radius of curvature
s	Spacing
s_0	Basic fastener spacing
r_{in}	Inner radius
t	Thickness
t_{pen}	Penetration depth
u_{creep}	Creep deformation
u_{fin}	Final deformation
$u_{fin,G}$	Final deformation for a permanent action G
$u_{fin,Q,1}$	Final deformation for the leading variable action Q_1
$u_{fin,Q,i}$	Final deformation for accompanying variable actions Q_i
u_{inst}	Instantaneous deformation
$u_{inst,G}$	Instantaneous deformation for a permanent action G
$u_{inst,Q,1}$	Instantaneous deformation for the leading variable action Q_1

$u_{inst,Q,i}$	Instantaneous deformation for accompanying variable actions Q_i
w_c	Precamber
w_{creep}	Creep deflection
w_{fin}	Final deflection
w_{inst}	Instantaneous deflection
$w_{net,fin}$	Net final deflection
v	Unit impulse velocity response
Greek lower case letters	
α	Angle between the x -direction and the force for a punched metal plate; Angle between the direction of the load and the loaded edge (or end)
β	Angle between the grain direction and the force for a punched metal plate
β_c	Straightness factor
γ	Angle between the x -direction and the timber connection line for a punched metal plate
γ_M	Partial factor for material properties, also accounting for model uncertainties and dimensional variations
λ_y	Slenderness ratio corresponding to bending about the y -axis
λ_z	Slenderness ratio corresponding to bending about the z -axis
$\lambda_{rel,y}$	Relative slenderness ratio corresponding to bending about the y -axis
$\lambda_{rel,z}$	Relative slenderness ratio corresponding to bending about the z -axis
ρ_k	Characteristic density
ρ_m	Mean density
$\sigma_{c,0,d}$	Design compressive stress along the grain
$\sigma_{c,\alpha,d}$	Design compressive stress at an angle α to the grain
$\sigma_{f,c,d}$	Mean design compressive stress of flange
$\sigma_{f,c,max,d}$	Design compressive stress of extreme fibres of flange
$\sigma_{f,t,d}$	Mean design tensile stress of flange
$\sigma_{f,t,max,d}$	Design tensile stress of extreme fibres of flange
$\sigma_{m,crit}$	Critical bending stress
$\sigma_{m,y,d}$	Design bending stress about the principal y -axis
$\sigma_{m,z,d}$	Design bending stress about the principal z -axis
$\sigma_{m,\alpha,d}$	Design bending stress at an angle α to the grain
σ_N	Axial stress
$\sigma_{t,0,d}$	Design tensile stress along the grain
$\sigma_{t,90,d}$	Design tensile stress perpendicular to the grain

Source: EN 1995-1-1:2004, 1.6

$\sigma_{w,c,d}$	Design compressive stress of web
$\sigma_{w,t,d}$	Design tensile stress of web
τ_d	Design shear stress
$\tau_{F,d}$	Design anchorage stress from axial force
$\tau_{M,d}$	Design anchorage stress from moment
$\tau_{tor,d}$	Design shear stress from torsion
ψ_0	Factor for combination value of a variable action
ψ_1	Factor for frequent value of a variable action
ψ_2	Factor for quasi-permanent value of a variable action
ζ	Modal damping ratio

Source: EN 1995-1-1:2004, 1.6

Non-liability

By using the content of *Design of timber structures – Volume 2*, you agree to the terms of use below.

The authors and reviewers have been responsible for interpreting building regulations, research papers, industrial documents and so on, with a view to conveying current design practices. The material presented is only intended to provide guidance; the final design responsibility lies with the structural engineer or designer.

All information is provided in its present state and without any form of guarantee, to the extent permitted by prevailing legislation. Although the publisher has taken all reasonable steps to try and provide reliable information in *Design of timber structures – Volume 2*, the publisher does not guarantee that the content is free from errors, mistakes and/or omissions, or that the content is up to date and relevant to the user's needs.

The publisher, Swedish Forest Industries Federation, also provides no guarantees for any outcomes arising from use of the information contained in *Design of timber structures – Volume 2*. All use of information in *Design of timber structures – Volume 2* is the user's own responsibility and is done at the user's risk.

Swedish Forest Industries Federation does not accept liability for any damage or injury that may arise due to the content of *Design of timber structures – Volume 2*.

Copyright

Swedish Forest Industries Federation owns the rights to the content *Design of timber structures – Volume 2*.

The content is protected under copyright law. Misuse will be subject to a penalty.
Copying of the content is prohibited.

Design of timber structures – Volume 2

© Swedish Forest Industries Federation, 2022
First UK edition

Publisher

Swedish Forest Industries Federation
Swedish Wood
P.O Box 55525
SE-102 04 STOCKHOLM
Sweden
Tel: +46 8762 72 60
E-mail: info@swedishwood.com
www.swedishwood.com

Project managers

Johan Fröbel – Swedish Wood
Patrice Godonou – Swedish Wood

Editor

Patrice Godonou – Swedish Wood

Fact checkers

Anders Gustafsson, RISE Research Institutes of Sweden
Marie Johansson, RISE Research Institutes of Sweden

Language reviewer

Patrice Godonou – Swedish Wood

Illustrations

Vendela Martinac – Thelander Arkitektur & Design AB
Cornelia Thelander – Thelander Arkitektur & Design AB

Photo credits

Åke E:son Lindman, page 9
Sören Håkanlind, page 20, 22, 25, 27, 29, 30, 34, 38, 40, 44

Graphic production

Formigo AB

ISBN 978-91-985212-9-0

Publications and websites from Swedish Wood

Publications

Order via www.swedishwood.com/publications.

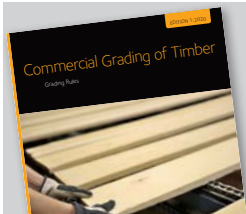

Commercial Grading of Timber

The recently updated basic manual for grading timber. 81 pages. A5 format.

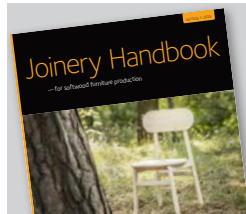

Joinery Handbook

Everything for small carpenters and students, from design to machine knowledge and surface treatments. 120 pages. A4 format.

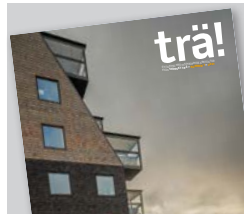

Trä! Magazine

Quarterly magazine showcasing the best in timber architecture and interior design from Sweden and beyond.

Digital publications available in the UK

Available at www.woodcampus.co.uk.

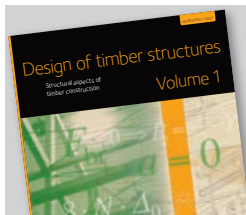

Design of timber structures, Volume 1

Structural aspects of timber construction. 256 pages. A4 format.

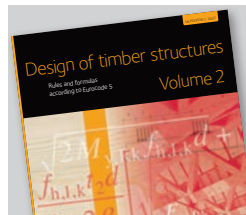

Design of timber structures, Volume 2

Rules and formulas according to Eurocode 5. 60 pages. A4 format.

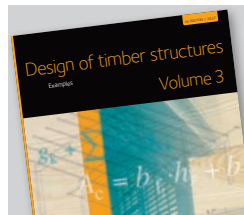

Design of timber structures, Volume 3

Examples. 60 pages. A4 format.

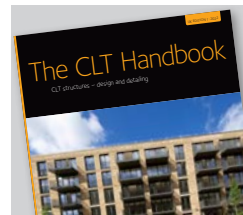

The CLT Handbook

CLT structures – design and detailing. 156 pages. A4 format.

Websites

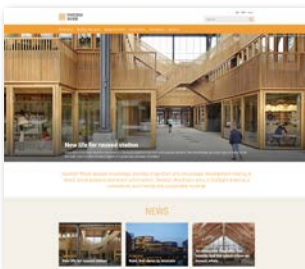

www.swedishwood.com

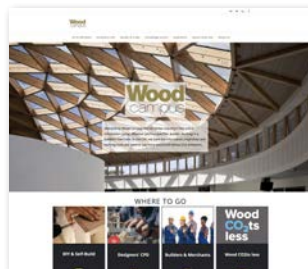

www.woodcampus.co.uk



Swedish Wood's aim is to increase the size and value of the market for Swedish wood and wood products in construction, interior design and packaging. Through inspiration, information and education, we promote wood as a competitive, renewable, versatile and natural material. Swedish Wood also lobbies on behalf of its members on key industry and trade issues.

Swedish Wood represents the Swedish sawmill industry and is part of the Swedish Forest Industries Federation. In addition, Swedish Wood represents the Swedish glulam, CLT and packaging industries, and collaborates closely with Swedish builders' merchants and wholesalers of wood products.

© Swedish Forest Industries Federation, 2022.

P.O Box 55525
SE-102 04 Stockholm
Sweden
Tel: +46 8 762 72 60
info@swedishwood.com
swedishwood.com



ISBN 978-91-985212-9-0